

BD234  
BD236  
BD238

**SILICON  
PNP POWER TRANSISTORS**



**TO-126 CASE**



[www.centrasemi.com](http://www.centrasemi.com)

**DESCRIPTION:**

The CENTRAL SEMICONDUCTOR BD234, BD236, and BD238 are silicon PNP power transistors designed for medium power amplifier and switching applications.

**MARKING: FULL PART NUMBER**

**MAXIMUM RATINGS:** ( $T_A=25^\circ\text{C}$  unless otherwise noted)

	<b>SYMBOL</b>	<b>BD234</b>	<b>BD236</b>	<b>BD238</b>	<b>UNITS</b>
Collector-Base Voltage	$V_{CB0}$	45	60	100	V
Collector-Emitter Voltage	$V_{CER}$	45	60	100	V
Collector-Emitter Voltage	$V_{CEO}$	45	60	80	V
Emitter-Base Voltage	$V_{EBO}$		5.0		V
Continuous Collector Current	$I_C$		2.0		A
Peak Collector Current	$I_{CM}$		6.0		A
Power Dissipation ( $T_C=25^\circ\text{C}$ )	$P_D$		25		W
Operating and Storage Junction Temperature	$T_J, T_{stg}$		-65 to +150		$^\circ\text{C}$

**ELECTRICAL CHARACTERISTICS:** ( $T_C=25^\circ\text{C}$ )

<b>SYMBOL</b>	<b>TEST CONDITIONS</b>	<b>BD234</b>		<b>BD236</b>		<b>BD238</b>		<b>UNITS</b>
		<b>MIN</b>	<b>MAX</b>	<b>MIN</b>	<b>MAX</b>	<b>MIN</b>	<b>MAX</b>	
$I_{CB0}$	$V_{CB}=\text{Rated } V_{CB0}$	-	100	-	100	-	100	$\mu\text{A}$
$I_{EBO}$	$V_{EB}=5.0\text{V}$	-	1.0	-	1.0	-	1.0	mA
$BV_{CEO}$	$I_C=100\text{mA}$	45	-	60	-	80	-	V
$V_{CE(\text{SAT})}$	$I_C=1.0\text{A}, I_B=100\text{mA}$	-	0.6	-	0.6	-	0.6	V
$V_{BE(\text{ON})}$	$V_{CE}=2.0\text{V}, I_C=1.0\text{A}$	-	1.3	-	1.3	-	1.3	V
$h_{FE}$	$V_{CE}=2.0\text{V}, I_C=150\text{mA}$	40	-	40	-	40	-	
$h_{FE}$	$V_{CE}=2.0\text{V}, I_C=1.0\text{A}$	25	-	25	-	25	-	
$f_T$	$V_{CE}=10\text{V}, I_C=250\text{mA}$	3.0	-	3.0	-	3.0	-	MHz

BD234  
BD236  
BD238

SILICON  
PNP POWER TRANSISTORS



TO-126 CASE - MECHANICAL OUTLINE

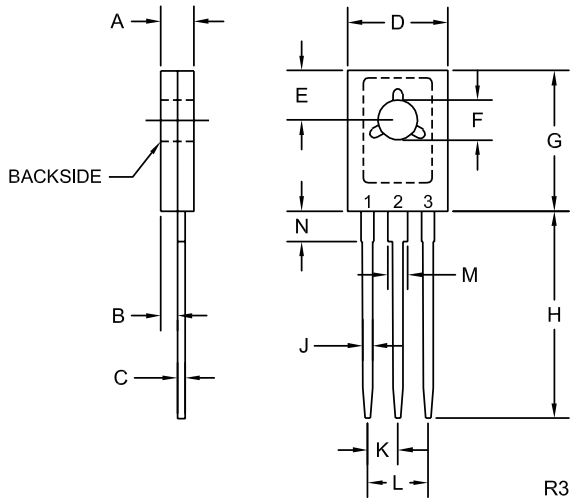

SYMBOL	DIMENSIONS			
	INCHES		MILLIMETERS	
	MIN	MAX	MIN	MAX
A	0.094	0.110	2.40	2.80
B	0.050		1.27	
C	0.015	0.030	0.38	0.75
D	0.291	0.335	7.40	8.50
E	0.148		3.75	
F	0.118	0.134	3.00	3.40
G	0.413	0.472	10.50	12.00
H	0.618		15.70	
J	0.024	0.035	0.62	0.90
K	0.089		2.25	
L	0.177		4.50	
M	0.045	0.055	1.14	1.40
N	0.083		2.10	

TO-126 (REV:R3)

LEAD CODE:

- 1) Emitter
- 2) Collector
- 3) Base

MARKING: FULL PART NUMBER

BD234  
BD236  
BD238

SILICON  
PNP POWER TRANSISTORS



TYPICAL ELECTRICAL CHARACTERISTICS

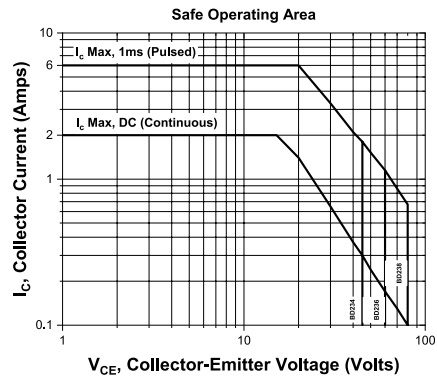
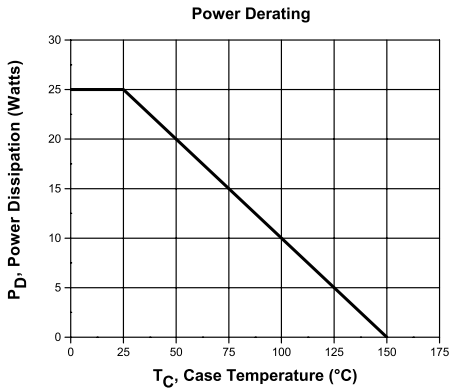
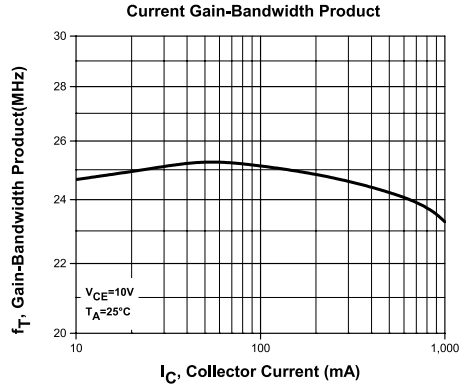
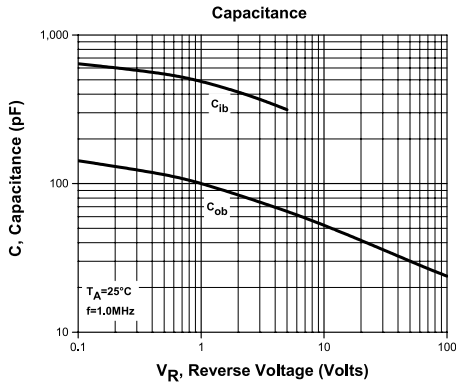
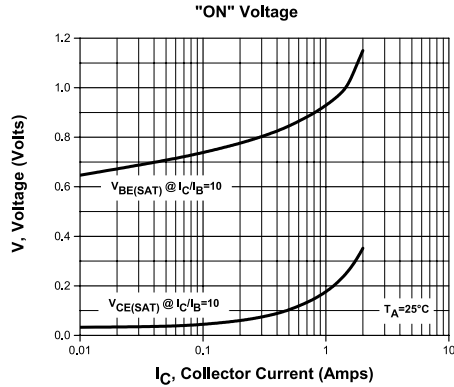
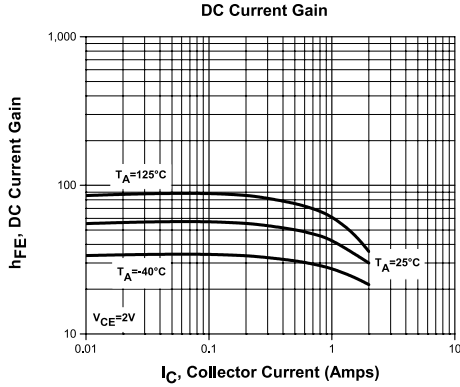

R1 (7-September 2022)

## OUTSTANDING SUPPORT AND SUPERIOR SERVICES



---

### PRODUCT SUPPORT

Central's operations team provides the highest level of support to insure product is delivered on-time.

- Supply management (Customer portals)
- Inventory bonding
- Consolidated shipping options
- Custom bar coding for shipments
- Custom product packing

---

### DESIGNER SUPPORT/SERVICES

Central's applications engineering team is ready to discuss your design challenges. Just ask.

- Free quick ship samples (2<sup>nd</sup> day air)
- Online technical data and parametric search
- SPICE models
- Custom electrical curves
- Environmental regulation compliance
- Customer specific screening
- Up-screening capabilities
- Special wafer diffusions
- PbSn plating options
- Package details
- Application notes
- Application and design sample kits
- Custom product and package development

---

### REQUESTING PRODUCT PLATING

1. If requesting Tin/Lead plated devices, add the suffix "TIN/LEAD" to the part number when ordering (example: 2N2222A TIN/LEAD).
2. If requesting Lead (Pb) Free plated devices, add the suffix "PBFREE" to the part number when ordering (example: 2N2222A PBFREE).

---

### CONTACT US

#### Corporate Headquarters & Customer Support Team

Central Semiconductor Corp.  
145 Adams Avenue  
Hauppauge, NY 11788 USA  
Main Tel: (631) 435-1110  
Main Fax: (631) 435-1824  
Support Team Fax: (631) 435-3388  
[www.centrasemi.com](http://www.centrasemi.com)

**Worldwide Field Representatives:**  
[www.centrasemi.com/wwreps](http://www.centrasemi.com/wwreps)

**Worldwide Distributors:**  
[www.centrasemi.com/wwdistributors](http://www.centrasemi.com/wwdistributors)

---

For the latest version of Central Semiconductor's **LIMITATIONS AND DAMAGES DISCLAIMER**, which is part of Central's Standard Terms and Conditions of sale, visit: [www.centrasemi.com/terms](http://www.centrasemi.com/terms)



<http://www.centrasemi.com>

# Product End of Life Notification

<b>PDN ID:</b>	PDN01250
<b>Notification Date:</b>	2/10/23
<b>Last Buy Date:</b>	Stock Only
<b>Last Shipment Date</b>	Stock Only

Please be advised that Central Semiconductor must immediately discontinue the product(s) listed in the attached PDN notice. Orders can only be accepted for products with available inventory on hand.

You may have purchased one or more of the products listed. Please do not hesitate to contact your local Central Semiconductor sales representative with any questions or needs you may have. Central regrets any inconvenience this may cause.

Sincerely,

Central Semiconductor Corp.

---

DISCLAIMER: This End of Life (EOL) notification is in accordance with JEDEC standard JESD48 - Product Discontinuance. Central Semiconductor Corp. will make every effort to offer life-time buy (LTB) opportunities and/or offer replacement devices to existing customers for discontinued devices, however, one or both may not be possible for all devices. Please contact your local Central Semiconductor sales representative for LTB opportunities/additional information.

# Product End of Life Notification

<b>PDN ID:</b>	PDN01250
<b>Notification Date:</b>	2/10/23
<b>Last Buy Date:</b>	Stock Only
<b>Last Shipment Date</b>	Stock Only

Summary: The following power transistors are discontinued and now classified as of End of Life (EOL). NOTE: If inventory has been depleted, some devices may be available on special order; please contact your Central salesperson, manufacturer's rep, franchised distributor, or [inquiry@centrasemi.com](mailto:inquiry@centrasemi.com).

Although Central Semiconductor Corp. makes every effort to continue to produce devices that have been proclaimed EOL (End of Life) by other manufacturers, it is an accepted industry practice to discontinue certain devices when customer demand falls below a minimum level of sustainability. Accordingly, the following product(s) have been transitioned to End of Life status as part of Central's ongoing Product Portfolio Management. Any replacement products are noted below. The effective date for placing last purchase orders will be six (6) months from the date of this notice and twelve (12) months from the notice date for final shipments, and minimum order quantities may apply. The last purchase and shipment dates may be extended if inventory is available.

**\* All Plating types (PBFREE, TIN/LEAD) for each item listed are included in this notice.**

<b>Central Part Number</b>	<b>Suggested Replacement</b>
BDW51	N/A
BDW51A	N/A
BDW51B	N/A
BDW51C	N/A
BDW52	N/A
BDW52A	N/A
BDW52B	N/A
BDW52C	N/A
BDW94B	N/A
BDX20	N/A
BDX54	N/A
BDX54B	N/A
BDX54C	N/A
BDX54E	N/A
BDX85	N/A
BDX85A	N/A
BDX85B	N/A
BDX85C	N/A
BDX87	N/A
BDX87A	N/A
BDX87B	N/A
BDX87C	N/A
BDY90	N/A
BD135	N/A
BD135 SL	N/A
BD135-10 SL	N/A
BD135-16	N/A
BD135-16 SL	N/A
BD136	N/A
BD136-10	N/A
BD136-10 SL	N/A
BD136-16	N/A
BD136-16 SL	N/A
BD137	N/A

\*\*\* CONTINUED \*\*\*

DISCLAIMER: This End of Life (EOL) notification is in accordance with JEDEC standard JESD48 - Product Discontinuance. Central Semiconductor Corp. will make every effort to offer life-time buy (LTB) opportunities and/or offer replacement devices to existing customers for discontinued devices, however, one or both may not be possible for all devices. Please contact your local Central Semiconductor sales representative for LTB opportunities/additional information.

# Product End of Life Notification

<b>PDN ID:</b>	PDN01250
<b>Notification Date:</b>	2/10/23
<b>Last Buy Date:</b>	Stock Only
<b>Last Shipment Date</b>	Stock Only

\*\*\* CONTINUED FROM PRIOR PAGE \*\*\*

\* All Plating types (PBFREE,TIN/LEAD) for each item listed are included in this notice.

<u>Central Part Number</u>	<u>Suggested Replacement</u>
BD137-10	N/A
BD137-10 SL	N/A
BD137-16	N/A
BD138	N/A
BD138-10	N/A
BD138-10 SL	N/A
BD138-16	N/A
BD138-16 SL	N/A
BD139	N/A
BD139-10	N/A
BD139-10 SL	N/A
BD139-16	N/A
BD139-16 SL	N/A
BD140	N/A
BD140-10	N/A
BD140-10 SL	N/A
BD140-16	N/A
BD140-16 SL	N/A
BD157	N/A
BD158	N/A
BD159	N/A
BD175	N/A
BD176	N/A
BD177	N/A
BD178	N/A
BD179	N/A
BD180	N/A
BD201	N/A
BD204	N/A
BD233	N/A
BD234	N/A
BD235	N/A
BD236	N/A
BD237	N/A
BD238	N/A
BD238 SL	N/A
BD433	N/A
BD434	N/A
BD437	N/A
BD438	N/A
BD439	N/A
BD440	N/A
BD441	N/A

\*\*\* CONTINUED \*\*\*

DISCLAIMER: This End of Life (EOL) notification is in accordance with JEDEC standard JESD48 - Product Discontinuance. Central Semiconductor Corp. will make every effort to offer life-time buy (LTB) opportunities and/or offer replacement devices to existing customers for discontinued devices, however, one or both may not be possible for all devices. Please contact your local Central Semiconductor sales representative for LTB opportunities/additional information.

# Product End of Life Notification

<b>PDN ID:</b>	PDN01250
<b>Notification Date:</b>	2/10/23
<b>Last Buy Date:</b>	Stock Only
<b>Last Shipment Date</b>	Stock Only

\*\*\* CONTINUED FROM PRIOR PAGE \*\*\*

\* All Plating types (PBFREE,TIN/LEAD) for each item listed are included in this notice.

<u>Central Part Number</u>	<u>Suggested Replacement</u>
BD442	N/A
BD537	N/A
BD538	N/A
BD675	N/A
BD675A	N/A
BD676	N/A
BD676A	N/A
BD676A SL	N/A
BD677	N/A
BD677A	N/A
BD678	N/A
BD678A	N/A
BD679	N/A
BD679A	N/A
BD679A SL	N/A
BD680	N/A
BD680A	N/A
BD680A SL	N/A
BD681	N/A
BD681 SL	N/A
BD682	N/A
BD682 SL	N/A
BD683	N/A
BD683 SL	N/A
BD908	N/A
BF457	N/A
BF458	N/A
BF459	N/A
BF459 SL	N/A
BF469	N/A
BF471	N/A
BF472	N/A
BUW34	N/A
BUW35	N/A
BUW36	N/A
BUW44	N/A
BUW45	N/A
BUW46	N/A
BUX43	N/A
BUX44	N/A
BUX47	N/A
BUX48	N/A
BUX80	N/A

\*\*\* CONTINUED \*\*\*

DISCLAIMER: This End of Life (EOL) notification is in accordance with JEDEC standard JESD48 - Product Discontinuance. Central Semiconductor Corp. will make every effort to offer life-time buy (LTB) opportunities and/or offer replacement devices to existing customers for discontinued devices, however, one or both may not be possible for all devices. Please contact your local Central Semiconductor sales representative for LTB opportunities/additional information.



# Product End of Life Notification

<b>PDN ID:</b>	PDN01250
<b>Notification Date:</b>	2/10/23
<b>Last Buy Date:</b>	Stock Only
<b>Last Shipment Date</b>	Stock Only

\*\*\* CONTINUED FROM PRIOR PAGE \*\*\*

\* All Plating types (PBFREE,TIN/LEAD) for each item listed are included in this notice.

<b>Central Part Number</b>	<b>Suggested Replacement</b>
BUY69A	N/A
BUY69B	N/A
BUY69C	N/A
BU408	N/A
BU409	N/A
CEN1025	N/A
CEN1037	N/A
CEN1063	N/A
CEN1092	N/A
CEN1102	N/A
CEN1111	N/A
CEN1177	N/A
CEN1247	N/A
CEN1306	N/A
CEN1323	N/A
CEN1328	N/A
CEN1364 SL	N/A
CEN1378 SL	N/A
CEN1391	N/A
CEN1396	N/A
CEN1406	N/A
CEN1416	N/A
CEN1439	N/A
CEN1450	N/A
CEN496	N/A
CEN537	N/A
CEN591	N/A
CEN596	N/A
CEN644	N/A
CEN671	N/A
CEN698-1	N/A
CEN698-2	N/A
CEN774	N/A
CEN821	N/A
CEN844	N/A
CEN925	N/A
CEN951	N/A
CEN961	N/A
CEN972	N/A
CEN992	N/A
CM3441	N/A
CP166-BUP54-WN	N/A
CP230-CZT122-CT	CP260-TIP122-CT

\*\*\* CONTINUED \*\*\*

DISCLAIMER: This End of Life (EOL) notification is in accordance with JEDEC standard JESD48 - Product Discontinuance. Central Semiconductor Corp. will make every effort to offer life-time buy (LTB) opportunities and/or offer replacement devices to existing customers for discontinued devices, however, one or both may not be possible for all devices. Please contact your local Central Semiconductor sales representative for LTB opportunities/additional information.

# Product End of Life Notification

<b>PDN ID:</b>	PDN01250
<b>Notification Date:</b>	2/10/23
<b>Last Buy Date:</b>	Stock Only
<b>Last Shipment Date</b>	Stock Only

\*\*\* CONTINUED FROM PRIOR PAGE \*\*\*

\* All Plating types (PBFREE,TIN/LEAD) for each item listed are included in this notice.

<b>Central Part Number</b>	<b>Suggested Replacement</b>
CP230-HTIP122-CM	N/A
CP230-H2N6039-CM	N/A
CP230-TIP122-CM	CP260-TIP122-CM
CP230-TIP122-CT	CP260-TIP122-CT
CP230-TIP122-CT20	N/A
CP230-2N6039-CM	N/A
CP230-2N6039-CT	N/A
CP230-2N6039-WN	N/A
CP630-CEN1263-WN	CP660-TIP127-WN
CP630-CZT127-CT	CP660-TIP127-CT
CP630-HTIP127-CM	N/A
CP630-TIP127-CT	CP660-TIP127-CT
CP630-TIP127-WN	CP660-TIP127-WN
CP630-2N6036-CT	N/A
CZT122 BK	N/A
CZT122 TR	N/A
CZT127 BK	N/A
CZT127 TR	N/A
CZT31C BK	N/A
CZT31C TR	N/A
D44C12	N/A
D44E1	N/A
D44E3	N/A
D45E3	N/A
D45H8	N/A
MJE13003	N/A
MJE13003 SL	N/A
MJE13005	N/A
MJE13005 SL	N/A
MJE13006	N/A
MJE13008	N/A
MJE13009	N/A
MJE15030	N/A
MJE15031	N/A
MJE170	N/A
MJE171	N/A
MJE172	N/A
MJE180	N/A
MJE181	N/A
MJE182	N/A
MJE200	N/A
MJE210	N/A
MJE220	N/A

\*\*\* CONTINUED \*\*\*

DISCLAIMER: This End of Life (EOL) notification is in accordance with JEDEC standard JESD48 - Product Discontinuance. Central Semiconductor Corp. will make every effort to offer life-time buy (LTB) opportunities and/or offer replacement devices to existing customers for discontinued devices, however, one or both may not be possible for all devices. Please contact your local Central Semiconductor sales representative for LTB opportunities/additional information.

# Product End of Life Notification

<b>PDN ID:</b>	PDN01250
<b>Notification Date:</b>	2/10/23
<b>Last Buy Date:</b>	Stock Only
<b>Last Shipment Date</b>	Stock Only

\*\*\* CONTINUED FROM PRIOR PAGE \*\*\*

\* All Plating types (PBFREE,TIN/LEAD) for each item listed are included in this notice.

<b>Central Part Number</b>	<b>Suggested Replacement</b>
MJE221	N/A
MJE222	N/A
MJE223	N/A
MJE224	N/A
MJE225	N/A
MJE230	N/A
MJE231	N/A
MJE232	N/A
MJE233	N/A
MJE234	N/A
MJE235	N/A
MJE2360T	N/A
MJE240	N/A
MJE241	N/A
MJE242	N/A
MJE243	N/A
MJE244	N/A
MJE250	N/A
MJE251	N/A
MJE252	N/A
MJE253	N/A
MJE254	N/A
MJE2801T	N/A
MJE2901T	N/A
MJE2955T	N/A
MJE340	N/A
MJE341	N/A
MJE344	N/A
MJE344 SL	N/A
MJE3440	N/A
MJE350	N/A
MJE370	N/A
MJE371	N/A
MJE520	N/A
MJE521	N/A
MJE700	N/A
MJE701	N/A
MJE702	N/A
MJE703	N/A
MJE710	N/A
MJE711	N/A
MJE712	N/A
MJE720	N/A

\*\*\* CONTINUED \*\*\*

DISCLAIMER: This End of Life (EOL) notification is in accordance with JEDEC standard JESD48 - Product Discontinuance. Central Semiconductor Corp. will make every effort to offer life-time buy (LTB) opportunities and/or offer replacement devices to existing customers for discontinued devices, however, one or both may not be possible for all devices. Please contact your local Central Semiconductor sales representative for LTB opportunities/additional information.

# Product End of Life Notification

<b>PDN ID:</b>	PDN01250
<b>Notification Date:</b>	2/10/23
<b>Last Buy Date:</b>	Stock Only
<b>Last Shipment Date</b>	Stock Only

\*\*\* CONTINUED FROM PRIOR PAGE \*\*\*

\* All Plating types (PBFREE,TIN/LEAD) for each item listed are included in this notice.

<b>Central Part Number</b>	<b>Suggested Replacement</b>
MJE721	N/A
MJE722	N/A
MJE800	N/A
MJE800T	N/A
MJE801	N/A
MJE801T	N/A
MJE802	N/A
MJE802T	N/A
MJE803	N/A
MJE803T	N/A
MJ1000	N/A
MJ1001	N/A
MJ10012	N/A
MJ11011	N/A
MJ11012	N/A
MJ11013	N/A
MJ11014	N/A
MJ11015	N/A
MJ11016	N/A
MJ2501	N/A
MJ2955	N/A
MJ3000	N/A
MJ3001	N/A
MJ4033	N/A
MJ4035	N/A
MJ410	N/A
MJ802	N/A
MJ901	N/A
PMD10K100	N/A
PMD10K40	N/A
PMD10K60	N/A
PMD10K80	N/A
PMD12K100	N/A
PMD12K40	N/A
PMD12K60	N/A
PMD12K80	N/A
PMD13K100	N/A
PMD16K100	N/A
PMD16K60	N/A
PMD16K80	N/A
PMD1601K	N/A
PMD1602K	N/A
PMD1603K	N/A

\*\*\* CONTINUED \*\*\*

DISCLAIMER: This End of Life (EOL) notification is in accordance with JEDEC standard JESD48 - Product Discontinuance. Central Semiconductor Corp. will make every effort to offer life-time buy (LTB) opportunities and/or offer replacement devices to existing customers for discontinued devices, however, one or both may not be possible for all devices. Please contact your local Central Semiconductor sales representative for LTB opportunities/additional information.

# Product End of Life Notification

PDN ID:	PDN01250
Notification Date:	2/10/23
Last Buy Date:	Stock Only
Last Shipment Date	Stock Only

\*\*\* CONTINUED FROM PRIOR PAGE \*\*\*

\* All Plating types (PBFREE,TIN/LEAD) for each item listed are included in this notice.

Central Part Number	Suggested Replacement
PMD17K100	N/A
PMD17K60	N/A
PMD17K80	N/A
PMD1701K	N/A
PMD1702K	N/A
PMD1703K	N/A
PMD18K100	N/A
PMD18K60	N/A
PMD18K80	N/A
PMD19K100	N/A
PMD19K60	N/A
PMD19K80	N/A
SE9303	N/A
SE9304	N/A
SE9305	N/A
TIP102	N/A
TIP107	N/A
TIP107 SL	N/A
TIP117	N/A
TIP117 SL	N/A
TIP122	N/A
TIP122 SL	N/A
TIP127	N/A
TIP127 SL	N/A
TIP132	N/A
TIP137	N/A
TIP140T	N/A
TIP141T	N/A
TIP142T	N/A
TIP145T	N/A
TIP146T	N/A
TIP147T	N/A
TIP29	N/A
TIP29A	N/A
TIP29A SL	N/A
TIP29B	N/A
TIP29C	N/A
TIP31	N/A
TIP31 SL	N/A
TIP31A	N/A
TIP31B	N/A
TIP31C SL	N/A
TIP32	N/A

\*\*\* CONTINUED \*\*\*

DISCLAIMER: This End of Life (EOL) notification is in accordance with JEDEC standard JESD48 - Product Discontinuance. Central Semiconductor Corp. will make every effort to offer life-time buy (LTB) opportunities and/or offer replacement devices to existing customers for discontinued devices, however, one or both may not be possible for all devices. Please contact your local Central Semiconductor sales representative for LTB opportunities/additional information.

# Product End of Life Notification

<b>PDN ID:</b>	PDN01250
<b>Notification Date:</b>	2/10/23
<b>Last Buy Date:</b>	Stock Only
<b>Last Shipment Date</b>	Stock Only

\*\*\* CONTINUED FROM PRIOR PAGE \*\*\*

\* All Plating types (PBFREE,TIN/LEAD) for each item listed are included in this notice.

<b>Central Part Number</b>	<b>Suggested Replacement</b>
TIP32A	N/A
TIP32A SL	N/A
TIP32B	N/A
TIP32C	N/A
TIP41	N/A
TIP41A	N/A
TIP41B	N/A
TIP41C	N/A
TIP41C SL	N/A
TIP42	N/A
TIP42A	N/A
TIP42B	N/A
TIP42C	N/A
TIP42C SL	N/A
TIP42D	N/A
2N3054	N/A
2N3055	N/A
2N3442	N/A
2N3448	N/A
2N3713	N/A
2N3714	N/A
2N3715	N/A
2N3716	N/A
2N3766	N/A
2N3767	N/A
2N3771	N/A
2N3772	N/A
2N3773	N/A
2N3789	N/A
2N3790	N/A
2N3791	N/A
2N3792	N/A
2N3902	N/A
2N4231	N/A
2N4232	N/A
2N4233	N/A
2N4347	N/A
2N4348	N/A
2N4398	N/A
2N4399	N/A
2N4901	N/A
2N4902	N/A
2N4903	N/A

\*\*\* CONTINUED \*\*\*

DISCLAIMER: This End of Life (EOL) notification is in accordance with JEDEC standard JESD48 - Product Discontinuance. Central Semiconductor Corp. will make every effort to offer life-time buy (LTB) opportunities and/or offer replacement devices to existing customers for discontinued devices, however, one or both may not be possible for all devices. Please contact your local Central Semiconductor sales representative for LTB opportunities/additional information.

# Product End of Life Notification

<b>PDN ID:</b>	PDN01250
<b>Notification Date:</b>	2/10/23
<b>Last Buy Date:</b>	Stock Only
<b>Last Shipment Date</b>	Stock Only

\*\*\* CONTINUED FROM PRIOR PAGE \*\*\*

\* All Plating types (PBFREE,TIN/LEAD) for each item listed are included in this notice.

<b>Central Part Number</b>	<b>Suggested Replacement</b>
2N4904	N/A
2N4905	N/A
2N4906	N/A
2N4910	N/A
2N4911	N/A
2N4912	N/A
2N4913	N/A
2N4914	N/A
2N4915	N/A
2N4918	N/A
2N4919	N/A
2N4920	N/A
2N4921	N/A
2N4922	N/A
2N4923	N/A
2N4923 SL	N/A
2N5067	N/A
2N5068	N/A
2N5069	N/A
2N5192	N/A
2N5192 SL	N/A
2N5195	N/A
2N5195 SL	N/A
2N5240	N/A
2N5294	N/A
2N5296	N/A
2N5297	N/A
2N5297 SL	N/A
2N5298	N/A
2N5301	N/A
2N5302	N/A
2N5303	N/A
2N5490	N/A
2N5492	N/A
2N5494	N/A
2N5496	N/A
2N5629	N/A
2N5632	N/A
2N5655	N/A
2N5656	N/A
2N5657	N/A
2N5745	N/A
2N5760	N/A

\*\*\* CONTINUED \*\*\*

DISCLAIMER: This End of Life (EOL) notification is in accordance with JEDEC standard JESD48 - Product Discontinuance. Central Semiconductor Corp. will make every effort to offer life-time buy (LTB) opportunities and/or offer replacement devices to existing customers for discontinued devices, however, one or both may not be possible for all devices. Please contact your local Central Semiconductor sales representative for LTB opportunities/additional information.

# Product End of Life Notification

<b>PDN ID:</b>	PDN01250
<b>Notification Date:</b>	2/10/23
<b>Last Buy Date:</b>	Stock Only
<b>Last Shipment Date</b>	Stock Only

\*\*\* CONTINUED FROM PRIOR PAGE \*\*\*

\* All Plating types (PBFREE,TIN/LEAD) for each item listed are included in this notice.

<b>Central Part Number</b>	<b>Suggested Replacement</b>
2N5838	N/A
2N5873	N/A
2N5875	N/A
2N5876	N/A
2N5877	N/A
2N5878	N/A
2N5879	N/A
2N5880	N/A
2N5881	N/A
2N5882	N/A
2N5883	N/A
2N5884	N/A
2N5885	N/A
2N5886	N/A
2N6029	N/A
2N6031	N/A
2N6034	N/A
2N6035	N/A
2N6036	N/A
2N6037	N/A
2N6038	N/A
2N6039 SL	N/A
2N6040	N/A
2N6042	N/A
2N6043	N/A
2N6044	N/A
2N6045	N/A
2N6050	N/A
2N6051	N/A
2N6052	N/A
2N6055	N/A
2N6056	N/A
2N6057	N/A
2N6058	N/A
2N6059	N/A
2N6099	N/A
2N6107	N/A
2N6109	N/A
2N6111	N/A
2N6121	N/A
2N6122	N/A
2N6123	N/A
2N6124	N/A

\*\*\* CONTINUED \*\*\*

DISCLAIMER: This End of Life (EOL) notification is in accordance with JEDEC standard JESD48 - Product Discontinuance. Central Semiconductor Corp. will make every effort to offer life-time buy (LTB) opportunities and/or offer replacement devices to existing customers for discontinued devices, however, one or both may not be possible for all devices. Please contact your local Central Semiconductor sales representative for LTB opportunities/additional information.



# Product End of Life Notification

<b>PDN ID:</b>	PDN01250
<b>Notification Date:</b>	2/10/23
<b>Last Buy Date:</b>	Stock Only
<b>Last Shipment Date</b>	Stock Only

\*\*\* CONTINUED FROM PRIOR PAGE \*\*\*

\* All Plating types (PBFREE,TIN/LEAD) for each item listed are included in this notice.

<b>Central Part Number</b>	<b>Suggested Replacement</b>
2N6125	N/A
2N6126	N/A
2N6129	N/A
2N6130	N/A
2N6131	N/A
2N6132	N/A
2N6133	N/A
2N6134	N/A
2N6226	N/A
2N6229	N/A
2N6230	N/A
2N6246	N/A
2N6247	N/A
2N6248	N/A
2N6249	N/A
2N6250	N/A
2N6251	N/A
2N6253	N/A
2N6254	N/A
2N6259	N/A
2N6260	N/A
2N6263	N/A
2N6282	N/A
2N6283	N/A
2N6284	N/A
2N6285	N/A
2N6286	N/A
2N6287	N/A
2N6288	N/A
2N6290	N/A
2N6292	N/A
2N6306	N/A
2N6307	N/A
2N6308	N/A
2N6312	N/A
2N6371	N/A
2N6383	N/A
2N6384	N/A
2N6385	N/A
2N6386	N/A
2N6387	N/A
2N6388	N/A
2N6465	N/A

\*\*\* CONTINUED \*\*\*

DISCLAIMER: This End of Life (EOL) notification is in accordance with JEDEC standard JESD48 - Product Discontinuance. Central Semiconductor Corp. will make every effort to offer life-time buy (LTB) opportunities and/or offer replacement devices to existing customers for discontinued devices, however, one or both may not be possible for all devices. Please contact your local Central Semiconductor sales representative for LTB opportunities/additional information.

# Product End of Life Notification

<b>PDN ID:</b>	PDN01250
<b>Notification Date:</b>	2/10/23
<b>Last Buy Date:</b>	Stock Only
<b>Last Shipment Date</b>	Stock Only

\*\*\* CONTINUED FROM PRIOR PAGE \*\*\*

\* All Plating types (PBFREE,TIN/LEAD) for each item listed are included in this notice.

<b>Central Part Number</b>	<b>Suggested Replacement</b>
2N6466	N/A
2N6469	N/A
2N6470	N/A
2N6471	N/A
2N6472	N/A
2N6475	N/A
2N6476	N/A
2N6489	N/A
2N6489 SL	N/A
2N6490	N/A
2N6491	N/A
2N6497	N/A
2N6498	N/A
2N6498 SL	N/A
2N6499	N/A
2N6499 SL	N/A
2N6530	N/A
2N6531	N/A
2N6532	N/A
2N6543	N/A
2N6544	N/A
2N6545	N/A
2N6546	N/A
2N6547	N/A
2N6569	N/A
2N6576	N/A
2N6577	N/A
2N6578	N/A
2N6594	N/A
2N6609	N/A
2N6666	N/A
2N6667	N/A
2N6668	N/A
2N6671	N/A
2N6672	N/A
2N6673	N/A
2N6674	N/A
2N6675	N/A
2N6677	N/A
2N6678	N/A
40250	N/A
40312	N/A

\*\*\* CONTINUED \*\*\*

DISCLAIMER: This End of Life (EOL) notification is in accordance with JEDEC standard JESD48 - Product Discontinuance. Central Semiconductor Corp. will make every effort to offer life-time buy (LTB) opportunities and/or offer replacement devices to existing customers for discontinued devices, however, one or both may not be possible for all devices. Please contact your local Central Semiconductor sales representative for LTB opportunities/additional information.



http://www.centrasemi.com

# Product End of Life Notification

<b>PDN ID:</b>	PDN01250
<b>Notification Date:</b>	2/10/23
<b>Last Buy Date:</b>	Stock Only
<b>Last Shipment Date</b>	Stock Only

\*\*\* CONTINUED FROM PRIOR PAGE \*\*\*

**\* All Plating types (PBFREE,TIN/LEAD) for each item listed are included in this notice.**

<b>Central Part Number</b>	<b>Suggested Replacement</b>
----------------------------	------------------------------

Central would be happy to assist you by providing additional information or technical data to help locate an alternate source if we have no replacement available. If you would like assistance, please visit <https://my.centrasemi.com/submit-inquiry?type=ER> to submit an online inquiry.

DISCLAIMER: This End of Life (EOL) notification is in accordance with JEDEC standard JESD48 - Product Discontinuance. Central Semiconductor Corp. will make every effort to offer life-time buy (LTB) opportunities and/or offer replacement devices to existing customers for discontinued devices, however, one or both may not be possible for all devices. Please contact your local Central Semiconductor sales representative for LTB opportunities/additional information.