

CBRDFA4-100

SURFACE MOUNT SILICON
4 AMP BRIDGE RECTIFIER



www.centrasemi.com

DESCRIPTION:

The CENTRAL SEMICONDUCTOR CBRDFA4-100 is a full wave bridge rectifier mounted in a durable epoxy surface mount case, utilizing glass passivated chips.

MARKING CODE: BR4100

FEATURES:

- High 4.0A Current Rating
- Low V_F Diodes (1.0V MAX @ $I_F=4.0A$)

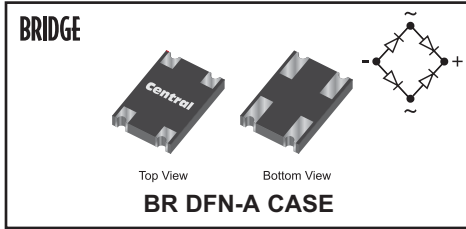

MAXIMUM RATINGS: ($T_A=25^\circ\text{C}$ unless otherwise noted)

	SYMBOL		UNITS
Peak Repetitive Reverse Voltage	V_{RRM}	1000	V
DC Blocking Voltage	V_R	1000	V
Average Forward Current ($T_C=112^\circ\text{C}$)	I_O	4.0	A
Peak Forward Surge Current (8.3ms)	I_{FSM}	150	A
Operating and Storage Junction Temperature	T_J, T_{stg}	-55 to +175	$^\circ\text{C}$

ELECTRICAL CHARACTERISTICS PER DIODE: ($T_A=25^\circ\text{C}$ unless otherwise noted)

SYMBOL	TEST CONDITIONS	TYP	MAX	UNITS
I_R	$V_R=1000V$		5.0	μA
V_F	$I_F=4.0A$	0.95	1.0	V
C_J	$V_R=4.0V, f=1.0\text{MHz}$	45		pF

R2 (23-June 2020)

CBR DFA4-100
SURFACE MOUNT SILICON
4 AMP BRIDGE RECTIFIER



BR DFN-A CASE - MECHANICAL OUTLINE

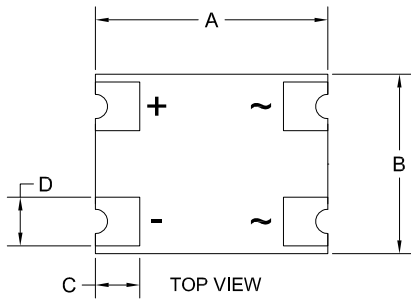

SYMBOL	INCHES		MILLIMETERS	
	MIN	MAX	MIN	MAX
A	0.409	0.417	10.40	10.60
B	0.315	0.323	8.00	8.20
C	0.073	0.085	1.85	2.15
D	0.083	0.091	2.10	2.30
E	0.049	0.061	1.25	1.55
F	0.083	0.091	2.10	2.30
G	0.138	0.146	3.50	3.70
H	0.201	0.209	5.10	5.30

BR DFN-A (REV: R0)

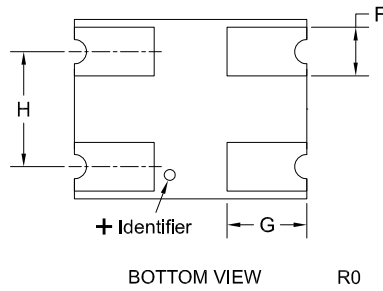
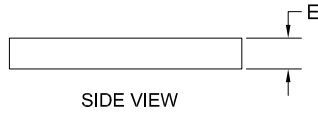

SUGGESTED MOUNTING PADS
 (Dimensions in mm)

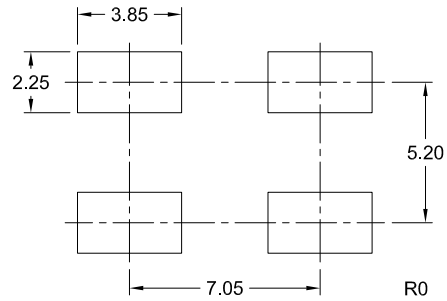

MARKING CODE: BR4100

R2 (23-June 2020)

CBRDFA4-100

SURFACE MOUNT SILICON
4 AMP BRIDGE RECTIFIER



TYPICAL ELECTRICAL CHARACTERISTICS

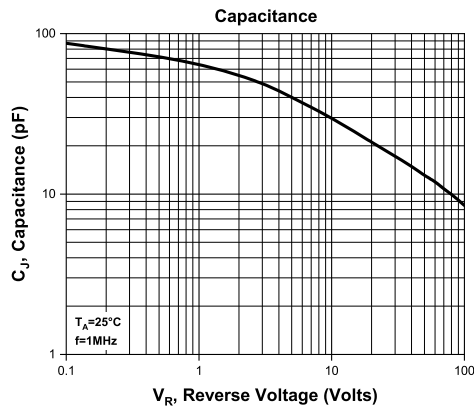
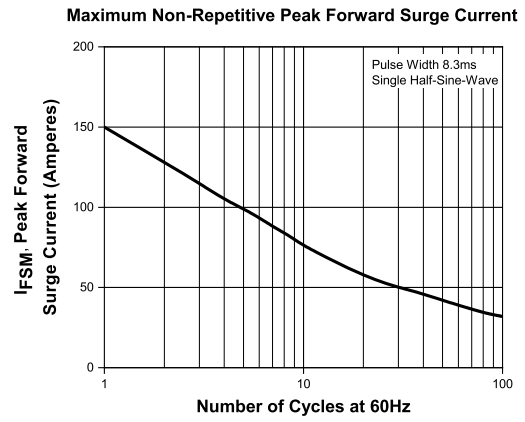
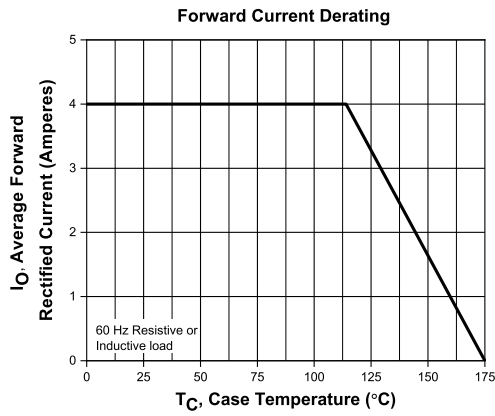

R2 (23-June 2020)

CBRDFA4-100

SURFACE MOUNT SILICON
4 AMP BRIDGE RECTIFIER



TYPICAL ELECTRICAL CHARACTERISTICS

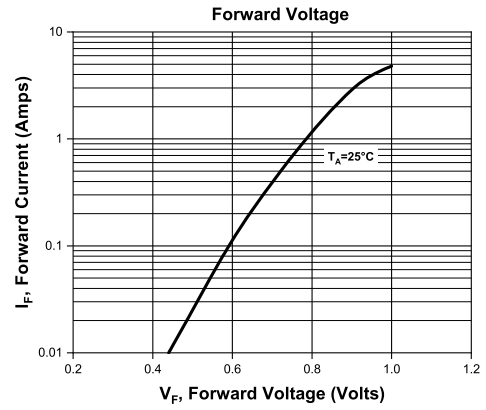
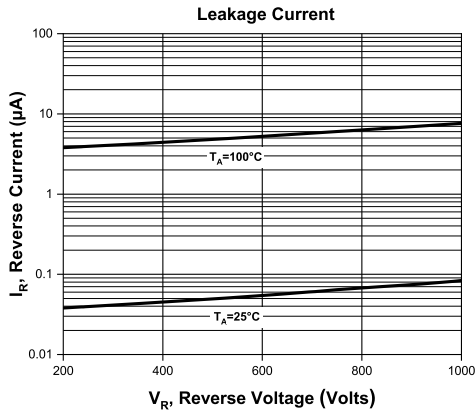

R2 (23-June 2020)

CBR DFA4-100
SURFACE MOUNT SILICON
4 AMP BRIDGE RECTIFIER



TYPICAL APPLICATIONS

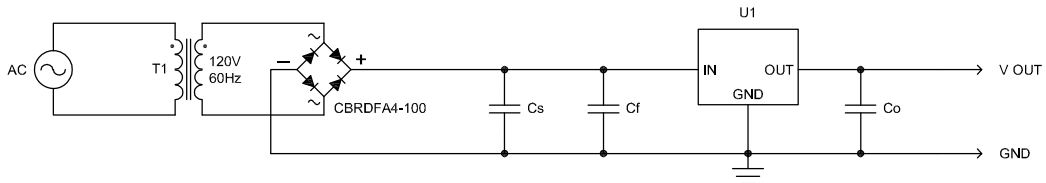

Figure 1. AC/DC Linear Regulator: The CBR DFA4-100 can provide AC to DC voltage rectification for linear regulation in any high power adapter or supply. AC voltage is converted to DC voltage and processed by a smoothing capacitor, where it then powers a linear regulator, yielding a flat DC output.

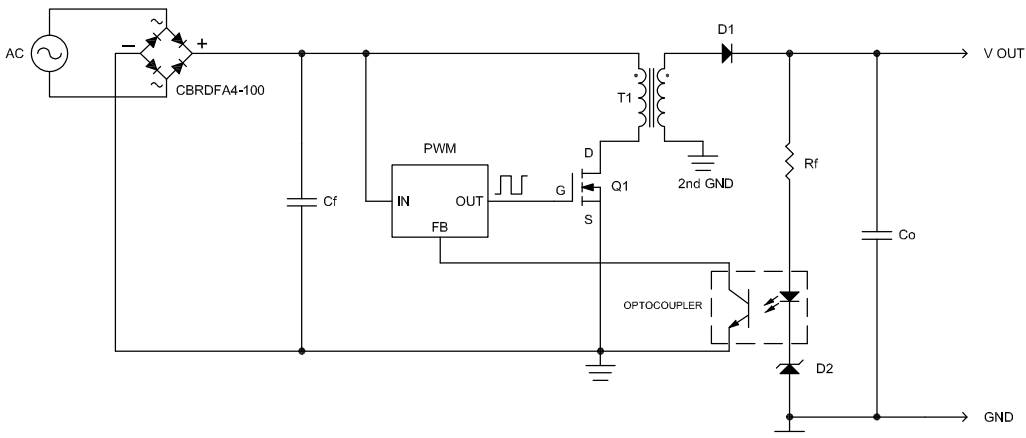

Figure 2. AC/DC Switched-Mode Power Supply: The CBR DFA4-100 provides a rectified DC signal to a PWM controlled MOSFET. The MOSFET acts as a switch, passing pulses of the signal through a transformer to a half-wave rectifier, which then converts the pulsed signal to DC. This DC signal is then used in a feedback loop with an optocoupler to power the PWM.

R2 (23-June 2020)

OUTSTANDING SUPPORT AND SUPERIOR SERVICES



PRODUCT SUPPORT

Central's operations team provides the highest level of support to insure product is delivered on-time.

- Supply management (Customer portals)
- Inventory bonding
- Consolidated shipping options
- Custom bar coding for shipments
- Custom product packing

DESIGNER SUPPORT/SERVICES

Central's applications engineering team is ready to discuss your design challenges. Just ask.

- Free quick ship samples (2nd day air)
- Online technical data and parametric search
- SPICE models
- Custom electrical curves
- Environmental regulation compliance
- Customer specific screening
- Up-screening capabilities
- Special wafer diffusions
- PbSn plating options
- Package details
- Application notes
- Application and design sample kits
- Custom product and package development

REQUESTING PRODUCT PLATING

1. If requesting Tin/Lead plated devices, add the suffix "TIN/LEAD" to the part number when ordering (example: 2N2222A TIN/LEAD).
2. If requesting Lead (Pb) Free plated devices, add the suffix "PBFREE" to the part number when ordering (example: 2N2222A PBFREE).

CONTACT US

Corporate Headquarters & Customer Support Team

Central Semiconductor Corp.
145 Adams Avenue
Hauppauge, NY 11788 USA
Main Tel: (631) 435-1110
Main Fax: (631) 435-1824
Support Team Fax: (631) 435-3388
www.centrasemi.com

Worldwide Field Representatives:
www.centrasemi.com/wwreps

Worldwide Distributors:
www.centrasemi.com/wwdistributors

For the latest version of Central Semiconductor's **LIMITATIONS AND DAMAGES DISCLAIMER**, which is part of Central's Standard Terms and Conditions of sale, visit: www.centrasemi.com/terms