

**CMDSH-3**  
**SURFACE MOUNT SILICON**  
**SCHOTTKY DIODE**



[www.centrasemi.com](http://www.centrasemi.com)

**DESCRIPTION:**

The CENTRAL SEMICONDUCTOR CMDSH-3 is a silicon Schottky diode, manufactured in an SOD-323 surface mount package, designed for fast switching applications requiring a low forward voltage drop.



**SOD-323 CASE**

**MARKING CODE: S1**

**MAXIMUM RATINGS:** ( $T_A=25^\circ\text{C}$  unless otherwise noted)

	<b>SYMBOL</b>		<b>UNITS</b>
Peak Repetitive Reverse Voltage	$V_{RRM}$	30	V
Average Forward Current	$I_O$	100	mA
Peak Forward Surge Current, $t_p=10\text{ms}$	$I_{FSM}$	750	mA
Power Dissipation	$P_D$	250	mW
Power Dissipation ( $T_L=25^\circ\text{C}$ )	$P_D$	833	mW
Operating and Storage Junction Temperature	$T_J, T_{stg}$	-65 to +150	$^\circ\text{C}$
Thermal Resistance	$\theta_{JA}$	500	$^\circ\text{C/W}$
Thermal Resistance	$\theta_{JL}$	150	$^\circ\text{C/W}$

**ELECTRICAL CHARACTERISTICS:** ( $T_A=25^\circ\text{C}$ )

<b>SYMBOL</b>	<b>TEST CONDITIONS</b>	<b>MIN</b>	<b>TYP</b>	<b>MAX</b>	<b>UNITS</b>
$I_R$	$V_R=25\text{V}$			1.0	$\mu\text{A}$
$BV_R$	$I_F=100\mu\text{A}$	30			V
$V_F$	$I_F=2.0\text{mA}$		0.29		V
$V_F$	$I_F=15\text{mA}$		0.37		V
$V_F$	$I_F=50\text{mA}$		0.44	0.55	V
$V_F$	$I_F=100\text{mA}$		0.51	0.80	V
$C_J$	$V_R=1.0\text{V}, f=1.0\text{MHz}$		7.0		pF

**CMDSH-3**  
**SURFACE MOUNT SILICON**  
**SCHOTTKY DIODE**



**SOD-323 CASE - MECHANICAL OUTLINE**

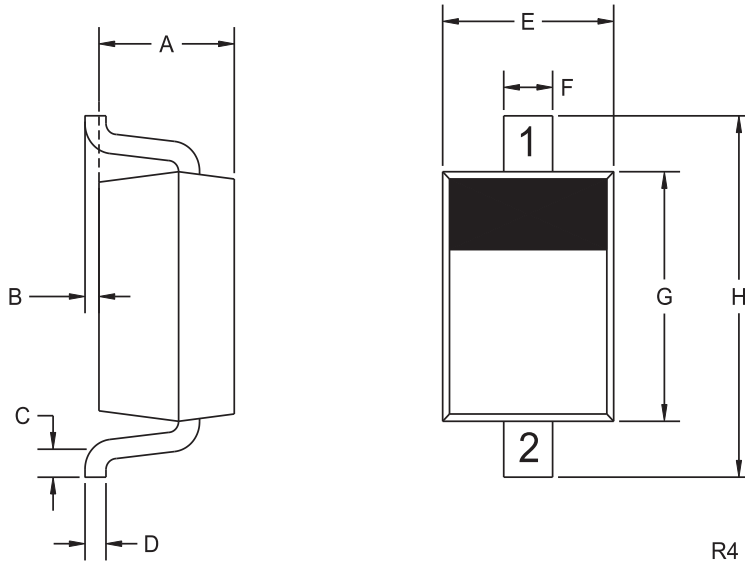

**LEAD CODE:**

- 1) Cathode
- 2) Anode

**MARKING CODE: S1**

SYMBOL	INCHES		MILLIMETERS	
	MIN	MAX	MIN	MAX
A	0.031	0.039	0.80	1.00
B	0.000	0.004	0.00	0.10
C	0.008	-	0.20	-
D	0.004	0.007	0.11	0.19
E	0.045	0.053	1.15	1.35
F	-	0.014	-	0.35
G	0.063	0.071	1.60	1.80
H	0.094	0.102	2.40	2.60

SOD-323 (REV: R4)

R9 (11-February 2016)

**CMDSH-3**  
**SURFACE MOUNT SILICON**  
**SCHOTTKY DIODE**



**TYPICAL ELECTRICAL CHARACTERISTICS**

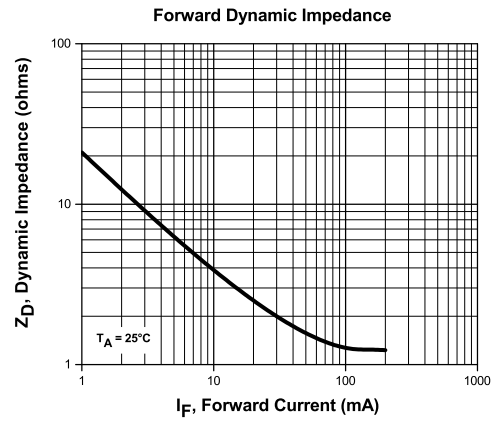
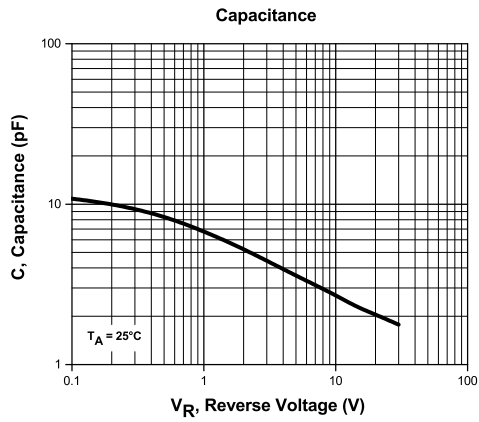
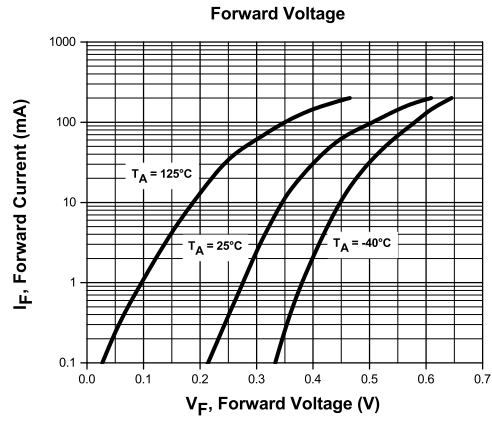
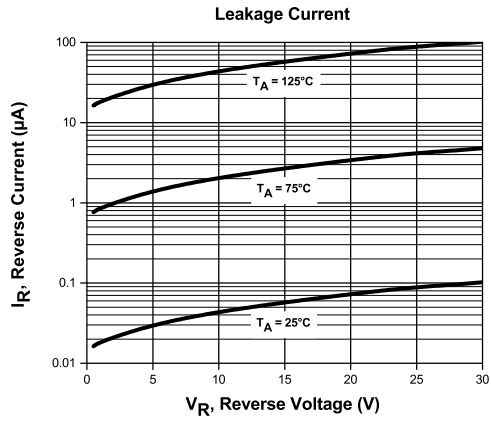

R9 (11-February 2016)

**CMDSH-3**  
**SURFACE MOUNT SILICON**  
**SCHOTTKY DIODE**



**TYPICAL ELECTRICAL CHARACTERISTICS**

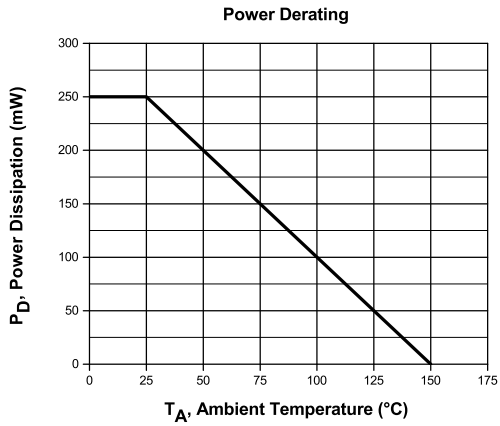
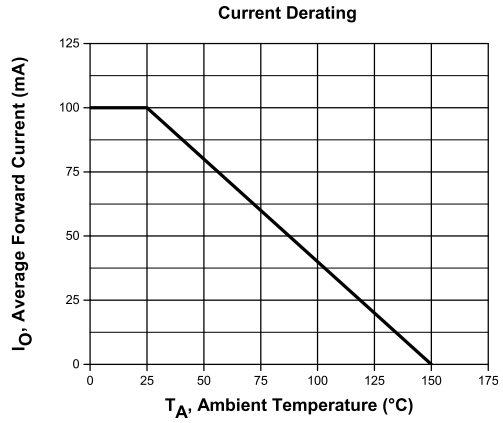
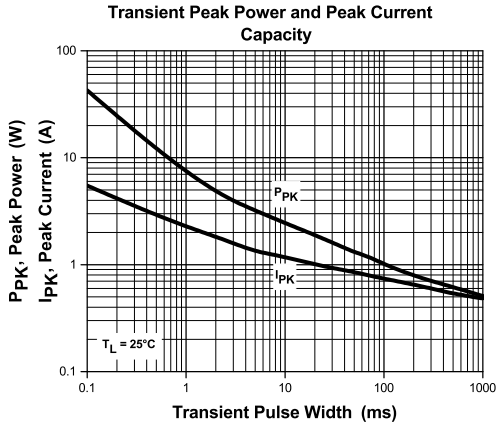

R9 (11-February 2016)

## OUTSTANDING SUPPORT AND SUPERIOR SERVICES



---

### PRODUCT SUPPORT

Central's operations team provides the highest level of support to insure product is delivered on-time.

- Supply management (Customer portals)
- Inventory bonding
- Consolidated shipping options
- Custom bar coding for shipments
- Custom product packing

---

### DESIGNER SUPPORT/SERVICES

Central's applications engineering team is ready to discuss your design challenges. Just ask.

- Free quick ship samples (2<sup>nd</sup> day air)
- Online technical data and parametric search
- SPICE models
- Custom electrical curves
- Environmental regulation compliance
- Customer specific screening
- Up-screening capabilities
- Special wafer diffusions
- PbSn plating options
- Package details
- Application notes
- Application and design sample kits
- Custom product and package development

---

### REQUESTING PRODUCT PLATING

1. If requesting Tin/Lead plated devices, add the suffix " TIN/LEAD" to the part number when ordering (example: 2N2222A TIN/LEAD).
2. If requesting Lead (Pb) Free plated devices, add the suffix " PBFREE" to the part number when ordering (example: 2N2222A PBFREE).

---

### CONTACT US

#### Corporate Headquarters & Customer Support Team

Central Semiconductor Corp.  
145 Adams Avenue  
Hauppauge, NY 11788 USA  
Main Tel: (631) 435-1110  
Main Fax: (631) 435-1824  
Support Team Fax: (631) 435-3388  
[www.centrasemi.com](http://www.centrasemi.com)

**Worldwide Field Representatives:**  
[www.centrasemi.com/wwreps](http://www.centrasemi.com/wwreps)

**Worldwide Distributors:**  
[www.centrasemi.com/wwdistributors](http://www.centrasemi.com/wwdistributors)

---

For the latest version of Central Semiconductor's **LIMITATIONS AND DAMAGES DISCLAIMER**, which is part of Central's Standard Terms and Conditions of sale, visit: [www.centrasemi.com/terms](http://www.centrasemi.com/terms)



http://www.centrasemi.com

# Product End of Life Notification

<b>PDN ID:</b>	PDN01227
<b>Notification Date:</b>	4/28/22
<b>Last Buy Date:</b>	10/28/22
<b>Last Shipment Date</b>	4/28/23

Summary: The CMDSH-3G Schottky diode is discontinued and now classified as Life (EOL).

Although Central Semiconductor Corp. makes every effort to continue to produce devices that have been proclaimed EOL (End of Life) by other manufacturers, it is an accepted industry practice to discontinue certain devices when customer demand falls below a minimum level of sustainability. Accordingly, the following product(s) have been transitioned to End of Life status as part of Central's ongoing Product Portfolio Management. Any replacement products are noted below. The effective date for placing last purchase orders will be six (6) months from the date of this notice and twelve (12) months from the notice date for final shipments, and minimum order quantities may apply. The last purchase and shipment dates may be extended if inventory is available.

**\* All Plating types (PBFREE,TIN/LEAD) for each item listed are included in this notice.**

<u>Central Part Number</u>	<u>Suggested Replacement</u>
CMDSH-3G BK	CMDSH-3 BK
CMDSH-3G TR	CMDSH-3 TR

Central would be happy to assist you by providing additional information or technical data to help locate an alternate source if we have no replacement available. If you would like assistance, please visit <https://my.centrasemi.com/submit-inquiry?type=ER> to submit an online inquiry.

DISCLAIMER: This End of Life (EOL) notification is in accordance with JEDEC standard JESD48 - Product Discontinuance. Central Semiconductor Corp. will make every effort to offer life-time buy (LTB) opportunities and/or offer replacement devices to existing customers for discontinued devices, however, one or both may not be possible for all devices. Please contact your local Central Semiconductor sales representative for LTB opportunities/additional information.