

CMLM0585

**MULTI DISCRETE MODULE™
SURFACE MOUNT SILICON
P-CHANNEL MOSFET AND
LOW V_F SCHOTTKY DIODE**



www.centrasemi.com

DESCRIPTION:

The CENTRAL SEMICONDUCTOR CMLM0585 is a Multi Discrete Module™ consisting of a single P-Channel enhancement-mode MOSFET and a low V_F Schottky diode packaged in a space saving SOT-563 surface mount case. This device is designed for small signal general purpose applications where size and operational efficiency are prime requirements.

MARKING CODE: 85C

FEATURES:

- High current MOSFET (I_D=650mA)
- ESD protection up to 1800V (Human Body Model)
- Low r_{DS(on)} MOSFET (0.5Ω MAX @ V_{GS}=2.5V)
- Low V_F Schottky diode (0.47V MAX @ 0.5A)

APPLICATIONS:

- DC-DC converters
- Boost converters
- Motor drive controls
- Battery powered portable equipment

MAXIMUM RATINGS - CASE: (T_A=25°C)

Power Dissipation (Note 1)
 Power Dissipation (Note 2)
 Power Dissipation (Note 3)
 Operating and Storage Junction Temperature
 Thermal Resistance (Note 1)

SYMBOL		UNITS
P _D	350	mW
P _D	300	mW
P _D	150	mW
T _J , T _{stg}	-65 to +150	°C
θ _{JA}	357	°C/W

MAXIMUM RATINGS - Q1: (T_A=25°C)

Drain-Source Voltage
 Gate-Source Voltage
 Continuous Drain Current

SYMBOL		UNITS
V _{DS}	20	V
V _{GS}	8.0	V
I _D	650	mA

MAXIMUM RATINGS - D1: (T_A=25°C)

Peak Repetitive Reverse Voltage
 Continuous Forward Current
 Peak Repetitive Forward Current, tp≤1.0ms
 Peak Forward Surge Current, tp=8.0ms

SYMBOL		UNITS
V _R RM	40	V
I _F	500	mA
I _F RM	3.5	A
I _F SM	10	A

ELECTRICAL CHARACTERISTICS - Q1: (T_A=25°C unless otherwise noted)

SYMBOL	TEST CONDITIONS	MIN	TYP	MAX	UNITS
I _{GSS} , I _{GSSR}	V _{GS} =4.5V, V _{DS} =0			10	μA
I _{DSS}	V _{DS} =16V, V _{GS} =0			100	nA
BV _{DSS}	V _{GS} =0, I _D =250μA	20			V
V _{GS(th)}	V _{DS} =V _{GS} , I _D =250μA	0.5		1.0	V
V _{SD}	V _{GS} =0, I _S =250mA			1.1	V
r _{DS(ON)}	V _{GS} =4.5V, I _D =350mA		0.25	0.36	Ω
r _{DS(ON)}	V _{GS} =2.5V, I _D =300mA		0.37	0.5	Ω
r _{DS(ON)}	V _{GS} =1.8V, I _D =150mA			0.8	Ω

Notes: (1) Ceramic or aluminum core PC Board with copper mounting pad area of 4.0mm²
 (2) FR-4 Epoxy PC Board with copper mounting pad area of 4.0mm²
 (3) FR-4 Epoxy PC Board with copper mounting pad area of 1.4mm²

R5 (1-July 2015)



CMLM0585

MULTI DISCRETE MODULE™
SURFACE MOUNT SILICON
P-CHANNEL MOSFET AND
LOW V_F SCHOTTKY DIODE



ELECTRICAL CHARACTERISTICS - Q1 Continued: (T_A=25°C unless otherwise noted)

SYMBOL	TEST CONDITIONS	MIN	TYP	MAX	UNITS
g _{FS}	V _{DS} =10V, I _D =200mA	200			mS
C _{rss}	V _{DS} =16V, V _{GS} =0, f=1.0MHz		25		pF
C _{iss}	V _{DS} =16V, V _{GS} =0, f=1.0MHz		100		pF
C _{oss}	V _{DS} =16V, V _{GS} =0, f=1.0MHz		21		pF
Q _{g(tot)}	V _{DS} =10V, V _{GS} =4.5V, I _D =200mA		1.2		nC
Q _{gs}	V _{DS} =10V, V _{GS} =4.5V, I _D =200mA		0.24		nC
Q _{gd}	V _{DS} =10V, V _{GS} =4.5V, I _D =200mA		0.36		nC
t _{on}	V _{DD} =10V, V _{GS} =4.5V, I _D =200mA, R _G =10Ω		38		ns
t _{off}	V _{DD} =10V, V _{GS} =4.5V, I _D =200mA, R _G =10Ω		48		ns

ELECTRICAL CHARACTERISTICS - D1: (T_A=25°C)

SYMBOL	TEST CONDITIONS	MIN	TYP	MAX	UNITS
I _R	V _R =10V			20	μA
I _R	V _R =30V			100	μA
BV _R	I _R =500μA	40			V
V _F	I _F =100μA			0.13	V
V _F	I _F =1.0mA			0.21	V
V _F	I _F =10mA			0.27	V
V _F	I _F =100mA			0.35	V
V _F	I _F =500mA			0.47	V
C _J	V _R =1.0V, f=1.0MHz			50	pF

SOT-563 CASE - MECHANICAL OUTLINE

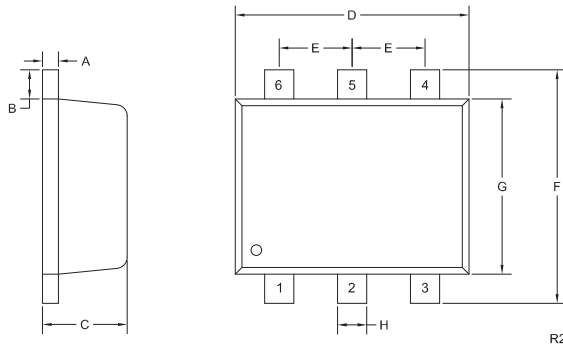

SYMBOL	DIMENSIONS			
	INCHES		MILLIMETERS	
	MIN	MAX	MIN	MAX
A	0.0027	0.007	0.07	0.18
B	0.008		0.20	
C	0.017	0.024	0.45	0.60
D	0.059	0.067	1.50	1.70
E	0.020		0.50	
F	0.059	0.067	1.50	1.70
G	0.043	0.051	1.10	1.30
H	0.006	0.012	0.15	0.30

SOT-563 (REV: R2)

LEAD CODE:

- 1) Gate Q1
- 2) Source Q1
- 3) Cathode D1
- 4) Anode D1
- 5) Anode D1
- 6) Drain Q1

MARKING CODE: 85C

R5 (1-July 2015)

CMLM0585

MULTI DISCRETE MODULE™
SURFACE MOUNT SILICON
P-CHANNEL MOSFET AND
LOW V_F SCHOTTKY DIODE



MOSFET TYPICAL ELECTRICAL CHARACTERISTICS

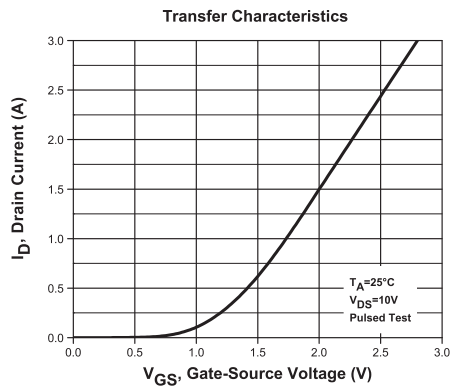
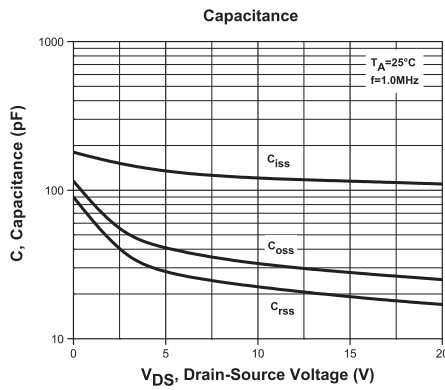
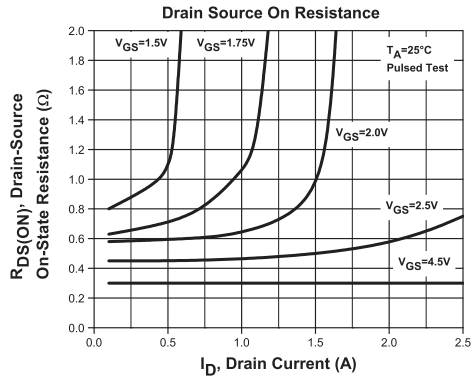
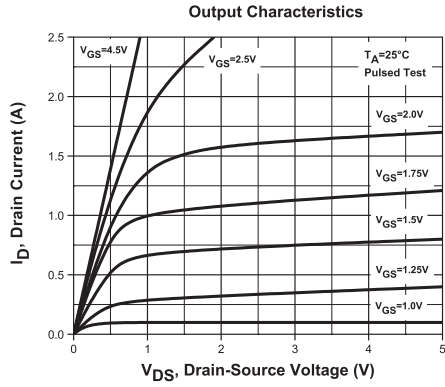

R5 (1-July 2015)

CMLM0585

MULTI DISCRETE MODULE™
SURFACE MOUNT SILICON
P-CHANNEL MOSFET AND
LOW V_F SCHOTTKY DIODE



DIODE TYPICAL ELECTRICAL CHARACTERISTICS

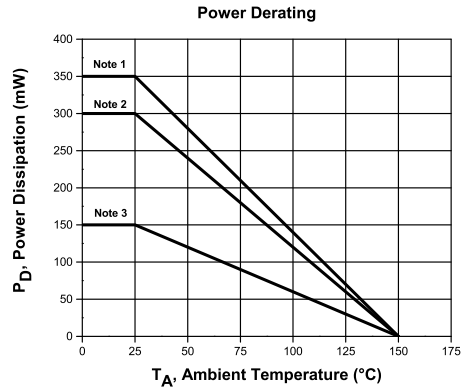
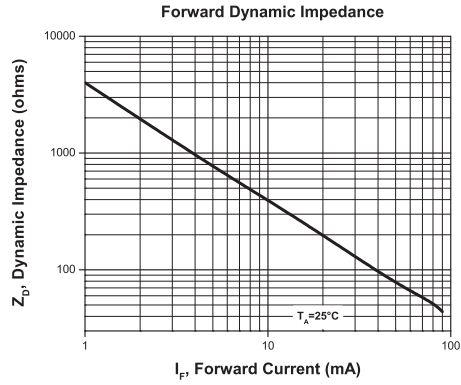
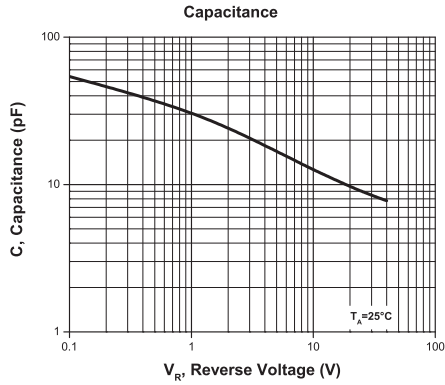
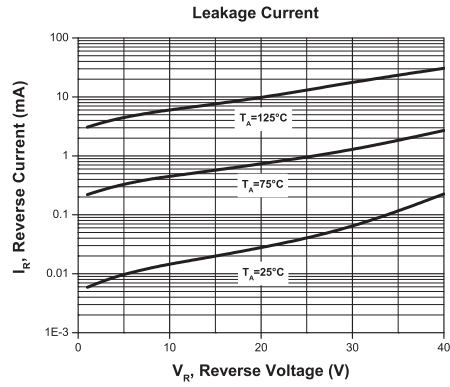
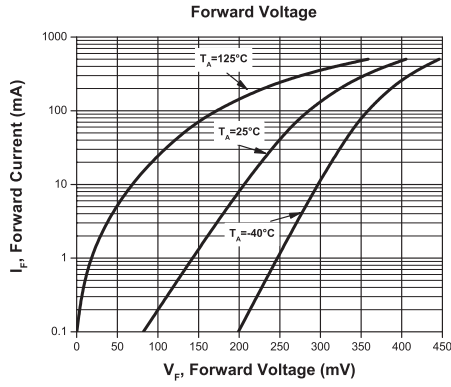

R5 (1-July 2015)

OUTSTANDING SUPPORT AND SUPERIOR SERVICES



PRODUCT SUPPORT

Central's operations team provides the highest level of support to insure product is delivered on-time.

- Supply management (Customer portals)
- Inventory bonding
- Consolidated shipping options
- Custom bar coding for shipments
- Custom product packing

DESIGNER SUPPORT/SERVICES

Central's applications engineering team is ready to discuss your design challenges. Just ask.

- Free quick ship samples (2nd day air)
- Online technical data and parametric search
- SPICE models
- Custom electrical curves
- Environmental regulation compliance
- Customer specific screening
- Up-screening capabilities
- Special wafer diffusions
- PbSn plating options
- Package details
- Application notes
- Application and design sample kits
- Custom product and package development

REQUESTING PRODUCT PLATING

1. If requesting Tin/Lead plated devices, add the suffix "TIN/LEAD" to the part number when ordering (example: 2N2222A TIN/LEAD).
2. If requesting Lead (Pb) Free plated devices, add the suffix "PBFREE" to the part number when ordering (example: 2N2222A PBFREE).

CONTACT US

Corporate Headquarters & Customer Support Team

Central Semiconductor Corp.
145 Adams Avenue
Hauppauge, NY 11788 USA
Main Tel: (631) 435-1110
Main Fax: (631) 435-1824
Support Team Fax: (631) 435-3388
www.centrasemi.com

Worldwide Field Representatives:
www.centrasemi.com/wwreps

Worldwide Distributors:
www.centrasemi.com/wwdistributors

For the latest version of Central Semiconductor's **LIMITATIONS AND DAMAGES DISCLAIMER**, which is part of Central's Standard Terms and Conditions of sale, visit: www.centrasemi.com/terms