

CMUSH2-4L

**SURFACE MOUNT SILICON
HIGH CURRENT
LOW V_F SCHOTTKY DIODE**



www.centrasemi.com

DESCRIPTION:

The CENTRAL SEMICONDUCTOR CMUSH2-4L is a high current, low V_F silicon Schottky diode in an SOT-523 surface mount package.

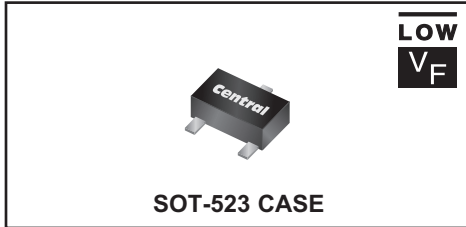
MARKING CODE: U24**APPLICATIONS:**

- Reverse polarity protection
- Voltage clamping
- Steering diode
- Flyback diode

FEATURES:

- Low forward voltage (240mV @ 10mA)
- High peak forward surge current (1.0A)
- Energy efficiency
- Space saving package

MAXIMUM RATINGS: ($T_A=25^\circ\text{C}$)

Peak Repetitive Reverse Voltage	V_{RRM}	40	V
Continuous Forward Current	I_F	200	mA
Peak Repetitive Forward Current	I_{FRM}	350	mA
Peak Forward Surge Current, $t_p=10\text{ms}$	I_{FSM}	1.0	A
Power Dissipation	P_D	250	mW
Operating and Storage Junction Temperature	T_J, T_{stg}	-65 to +150	$^\circ\text{C}$
Thermal Resistance	θ_{JA}	500	$^\circ\text{C/W}$

SYMBOL

SYMBOL		UNITS
V_{RRM}	40	V
I_F	200	mA
I_{FRM}	350	mA
I_{FSM}	1.0	A
P_D	250	mW
T_J, T_{stg}	-65 to +150	$^\circ\text{C}$
θ_{JA}	500	$^\circ\text{C/W}$

ELECTRICAL CHARACTERISTICS: ($T_A=25^\circ\text{C}$ unless otherwise noted)

SYMBOL	TEST CONDITIONS	MIN	TYP	MAX	UNITS
I_R	$V_R=20\text{V}$		11	50	μA
BV_R	$I_R=100\mu\text{A}$	40	53		V
V_F	$I_F=10\text{mA}$		0.24	0.325	V
V_F	$I_F=100\text{mA}$		0.35	0.4	V
V_F	$I_F=200\text{mA}$		0.42	0.5	V
C_J	$V_R=4.0\text{V}, f=1.0\text{MHz}$		8.5	10	pF
t_{rr}	$I_F=I_R=10\text{mA}, I_{rr}=1.0\text{mA}, R_L=100\Omega$		4.0	5.0	ns

CMUSH2-4L
SURFACE MOUNT SILICON
HIGH CURRENT
LOW V_F SCHOTTKY DIODE



SOT-523 CASE - MECHANICAL OUTLINE

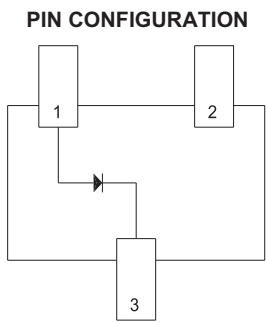
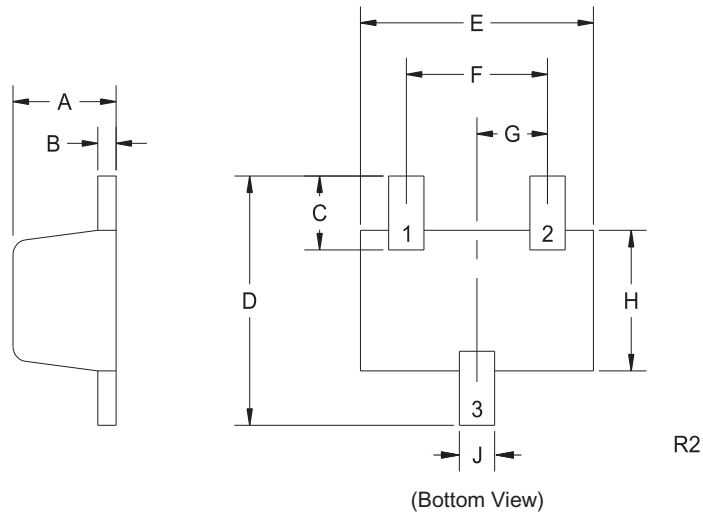

SYMBOL	INCHES		MILLIMETERS	
	MIN	MAX	MIN	MAX
A	0.023	0.031	0.58	0.78
B	0.002	0.008	0.04	0.20
C	0.013	0.021	0.34	0.54
D	0.059	0.067	1.50	1.70
E	0.059	0.067	1.50	1.70
F	0.035	0.043	0.90	1.10
G	0.020		0.50	
H	0.031	0.039	0.78	0.98
J	0.010	0.014	0.25	0.35

SOT-523 (REV: R2)

LEAD CODE:

- 1) Anode
- 2) No Connection
- 3) Cathode

MARKING CODE: U24

R4 (13-November 2015)

CMUSH2-4L

SURFACE MOUNT SILICON
HIGH CURRENT
LOW V_F SCHOTTKY DIODE



TYPICAL ELECTRICAL CHARACTERISTICS

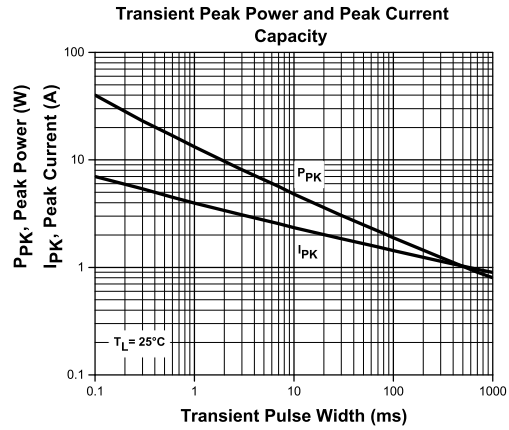
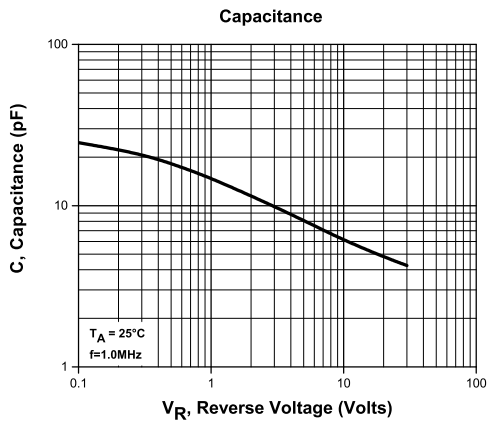
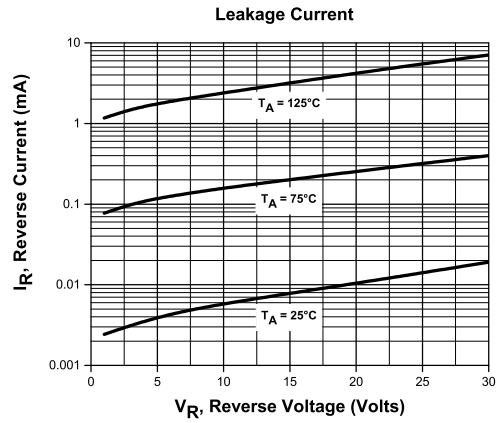
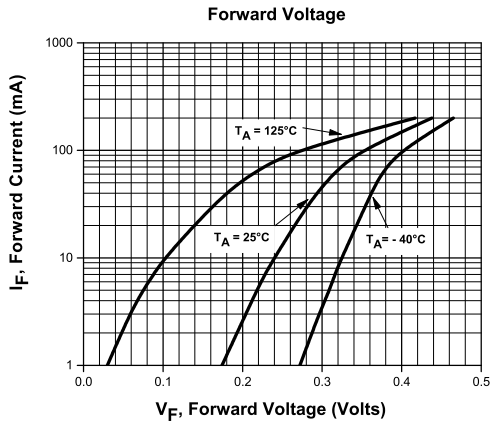

R4 (13-November 2015)

CMUSH2-4L
SURFACE MOUNT SILICON
HIGH CURRENT
LOW V_F SCHOTTKY DIODE



TYPICAL ELECTRICAL CHARACTERISTICS

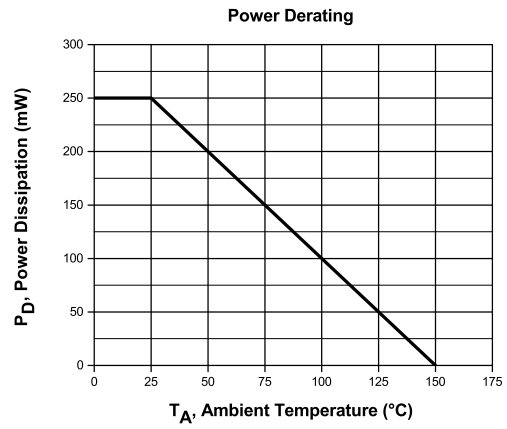
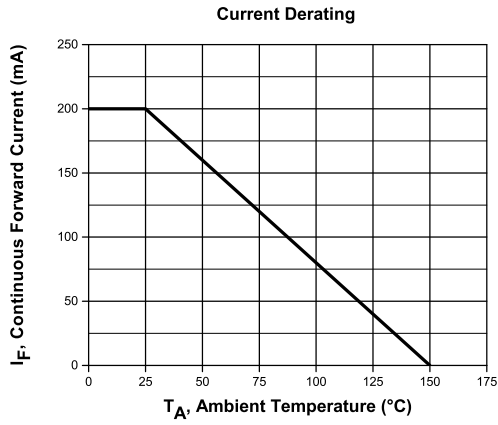

R4 (13-November 2015)

OUTSTANDING SUPPORT AND SUPERIOR SERVICES



PRODUCT SUPPORT

Central's operations team provides the highest level of support to insure product is delivered on-time.

- Supply management (Customer portals)
- Inventory bonding
- Consolidated shipping options
- Custom bar coding for shipments
- Custom product packing

DESIGNER SUPPORT/SERVICES

Central's applications engineering team is ready to discuss your design challenges. Just ask.

- Free quick ship samples (2nd day air)
- Online technical data and parametric search
- SPICE models
- Custom electrical curves
- Environmental regulation compliance
- Customer specific screening
- Up-screening capabilities
- Special wafer diffusions
- PbSn plating options
- Package details
- Application notes
- Application and design sample kits
- Custom product and package development

REQUESTING PRODUCT PLATING

1. If requesting Tin/Lead plated devices, add the suffix "TIN/LEAD" to the part number when ordering (example: 2N2222A TIN/LEAD).
2. If requesting Lead (Pb) Free plated devices, add the suffix "PBFREE" to the part number when ordering (example: 2N2222A PBFREE).

CONTACT US

Corporate Headquarters & Customer Support Team

Central Semiconductor Corp.
145 Adams Avenue
Hauppauge, NY 11788 USA
Main Tel: (631) 435-1110
Main Fax: (631) 435-1824
Support Team Fax: (631) 435-3388
www.centrasemi.com

Worldwide Field Representatives:
www.centrasemi.com/wwreps

Worldwide Distributors:
www.centrasemi.com/wwdistributors

For the latest version of Central Semiconductor's **LIMITATIONS AND DAMAGES DISCLAIMER**, which is part of Central's Standard Terms and Conditions of sale, visit: www.centrasemi.com/terms

Product End of Life Notification

PDN ID:	PDN01233
Notification Date:	6/01/22
Last Buy Date:	12/01/22
Last Shipment Date	6/01/23

Summary: The CMUSH2-4 series Schottky diodes are discontinued and now classified as Life (EOL).

Although Central Semiconductor Corp. makes every effort to continue to produce devices that have been proclaimed EOL (End of Life) by other manufacturers, it is an accepted industry practice to discontinue certain devices when customer demand falls below a minimum level of sustainability. Accordingly, the following product(s) have been transitioned to End of Life status as part of Central's ongoing Product Portfolio Management. Any replacement products are noted below. The effective date for placing last purchase orders will be six (6) months from the date of this notice and twelve (12) months from the notice date for final shipments, and minimum order quantities may apply. The last purchase and shipment dates may be extended if inventory is available.

*** All Plating types (PBFREE, TIN/LEAD) for each item listed are included in this notice.**

Central Part Number	Suggested Replacement
CMUSH2-4 BK	N/A
CMUSH2-4 TR	N/A
CMUSH2-4A BK	N/A
CMUSH2-4A TR	N/A
CMUSH2-4C BK	N/A
CMUSH2-4C TR	N/A
CMUSH2-4L BK	N/A
CMUSH2-4L TR	N/A
CMUSH2-4S BK	N/A
CMUSH2-4S TR	N/A

Central would be happy to assist you by providing additional information or technical data to help locate an alternate source if we have no replacement available. If you would like assistance, please visit <https://my.centralsemi.com/submit-inquiry?type=ER> to submit an online inquiry.

DISCLAIMER: This End of Life (EOL) notification is in accordance with JEDEC standard JESD48 - Product Discontinuance. Central Semiconductor Corp. will make every effort to offer life-time buy (LTB) opportunities and/or offer replacement devices to existing customers for discontinued devices, however, one or both may not be possible for all devices. Please contact your local Central Semiconductor sales representative for LTB opportunities/additional information.