

CMXSH-3
SURFACE MOUNT SILICON
TRIPLE ISOLATED
SCHOTTKY DIODE



www.centrasemi.com

DESCRIPTION:

The CENTRAL SEMICONDUCTOR CMXSH-3 contains three (3) isolated silicon Schottky switching diodes, manufactured by the epitaxial planar process, epoxy molded in an SOT-26 surface mount package, and designed for applications requiring low forward voltage drop

MARKING CODE: XH3



MAXIMUM RATINGS: ($T_A=25^{\circ}\text{C}$)

	SYMBOL		UNITS
Peak Repetitive Reverse Voltage	V_{RRM}	30	V
Continuous Forward Current	I_F	100	mA
Peak Repetitive Forward Current	I_{FRM}	350	mA
Peak Forward Surge Current, $t_p=10\text{ms}$	I_{FSM}	750	mA
Power Dissipation	P_D	350	mW
Operating and Storage Junction Temperature	T_J, T_{stg}	-65 to +150	$^{\circ}\text{C}$
Thermal Resistance	θ_{JA}	357	$^{\circ}\text{C}/\text{W}$

ELECTRICAL CHARACTERISTICS PER DIODE: ($T_A=25^{\circ}\text{C}$ unless otherwise noted)

SYMBOL	TEST CONDITIONS	MIN	TYP	MAX	UNITS
I_R	$V_R=25\text{V}$		90	500	nA
I_R	$V_R=25\text{V}, T_A=100^{\circ}\text{C}$		25	100	μA
BV_R	$I_R=100\mu\text{A}$	30			V
V_F	$I_F=2.0\text{mA}$		0.29	0.33	V
V_F	$I_F=15\text{mA}$		0.37	0.45	V
V_F	$I_F=100\text{mA}$		0.51	1.00	V
C_J	$V_R=1.0\text{V}, f=1.0\text{MHz}$		7.0		pF
t_{rr}	$I_F=I_R=10\text{mA}, I_{rr}=1.0\text{mA}, R_L=100\Omega$			5.0	ns

CMXSH-3
SURFACE MOUNT SILICON
TRIPLE ISOLATED
SCHOTTKY DIODE



SOT-26 CASE - MECHANICAL OUTLINE

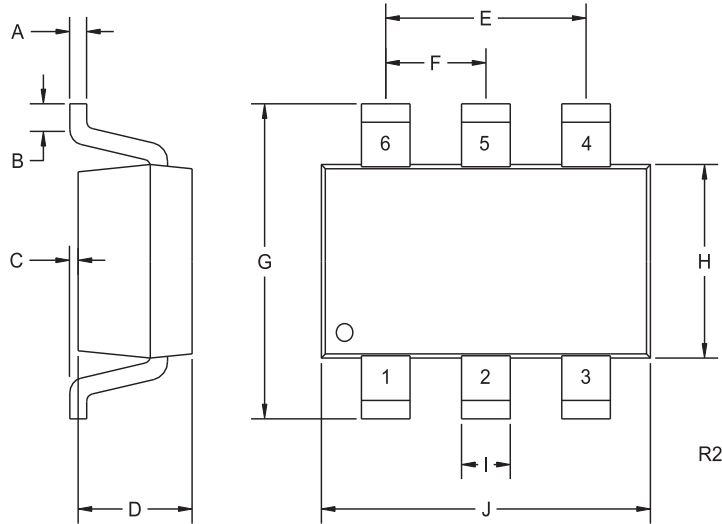

PIN CONFIGURATION

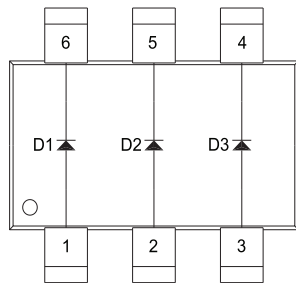

SYMBOL	INCHES		MILLIMETERS	
	MIN	MAX	MIN	MAX
A	0.004	0.007	0.11	0.19
B	0.016	-	0.40	-
C	-	0.004	-	0.10
D	0.039	0.047	1.00	1.20
E	0.074	0.075	1.88	1.92
F	0.037	0.038	0.93	0.97
G	0.102	0.118	2.60	3.00
H	0.059	0.067	1.50	1.70
I	0.016		0.41	
J	0.110	0.118	2.80	3.00

SOT-26 (REV: R2)

LEAD CODE:

- 1) Anode D1
- 2) Anode D2
- 3) Anode D3
- 4) Cathode D3
- 5) Cathode D2
- 6) Cathode D1

MARKING CODE: XH3

R6 (11-February 2016)

CMXSH-3
SURFACE MOUNT SILICON
TRIPLE ISOLATED
SCHOTTKY DIODE



TYPICAL ELECTRICAL CHARACTERISTICS

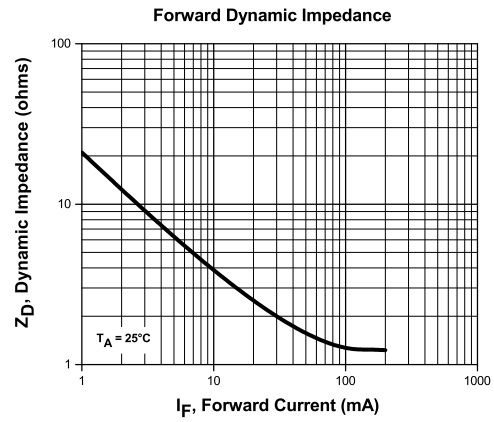
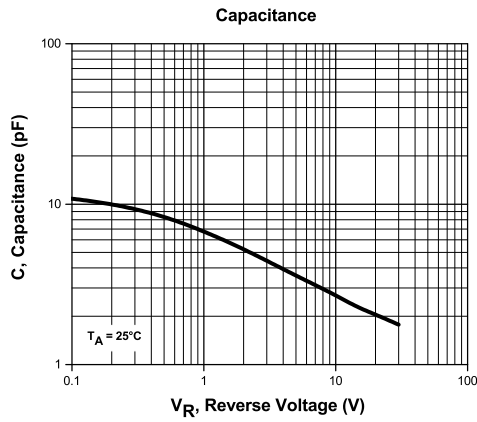
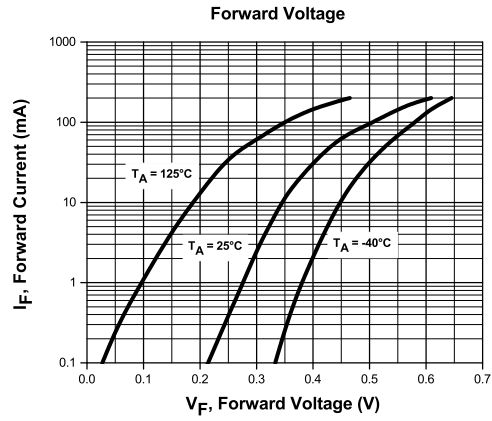
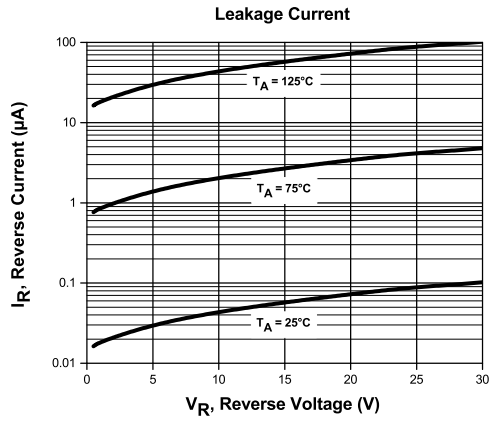

R6 (11-February 2016)

CMXSH-3

SURFACE MOUNT SILICON
TRIPLE ISOLATED
SCHOTTKY DIODE



TYPICAL ELECTRICAL CHARACTERISTICS

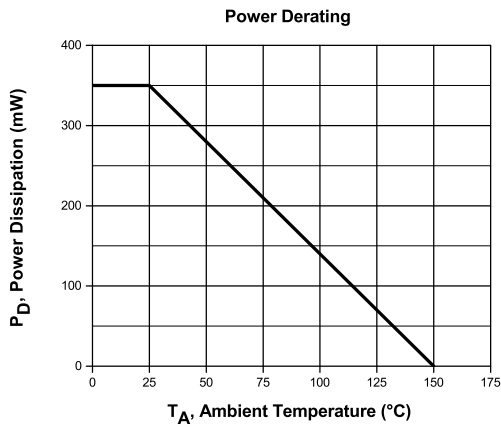
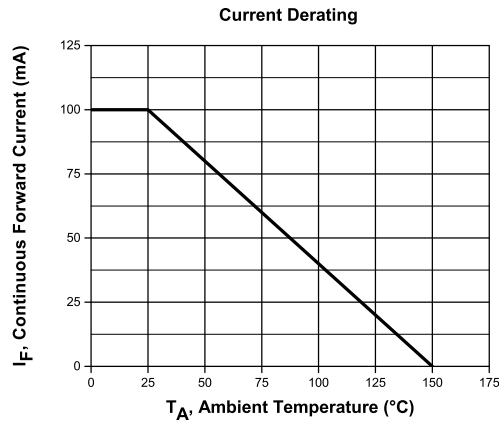
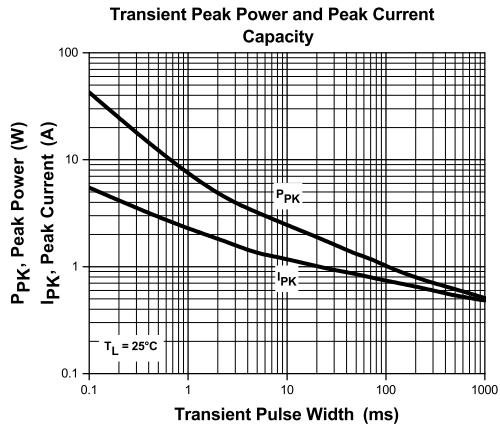

R6 (11-February 2016)

OUTSTANDING SUPPORT AND SUPERIOR SERVICES



PRODUCT SUPPORT

Central's operations team provides the highest level of support to insure product is delivered on-time.

- Supply management (Customer portals)
- Inventory bonding
- Consolidated shipping options
- Custom bar coding for shipments
- Custom product packing

DESIGNER SUPPORT/SERVICES

Central's applications engineering team is ready to discuss your design challenges. Just ask.

- Free quick ship samples (2nd day air)
- Online technical data and parametric search
- SPICE models
- Custom electrical curves
- Environmental regulation compliance
- Customer specific screening
- Up-screening capabilities
- Special wafer diffusions
- PbSn plating options
- Package details
- Application notes
- Application and design sample kits
- Custom product and package development

REQUESTING PRODUCT PLATING

1. If requesting Tin/Lead plated devices, add the suffix "TIN/LEAD" to the part number when ordering (example: 2N2222A TIN/LEAD).
2. If requesting Lead (Pb) Free plated devices, add the suffix "PBFREE" to the part number when ordering (example: 2N2222A PBFREE).

CONTACT US

Corporate Headquarters & Customer Support Team

Central Semiconductor Corp.
145 Adams Avenue
Hauppauge, NY 11788 USA
Main Tel: (631) 435-1110
Main Fax: (631) 435-1824
Support Team Fax: (631) 435-3388
www.centrasemi.com

Worldwide Field Representatives:
www.centrasemi.com/wwreps

Worldwide Distributors:
www.centrasemi.com/wwdistributors

For the latest version of Central Semiconductor's **LIMITATIONS AND DAMAGES DISCLAIMER**, which is part of Central's Standard Terms and Conditions of sale, visit: www.centrasemi.com/terms