

CPD35-CMP SH-3

Schottky Diode Die

0.1 Amp, 30 Volt

The CPD35-CMP SH-3 is a silicon 0.1 Amp, 30 Volt Schottky diode designed for fast switching applications.

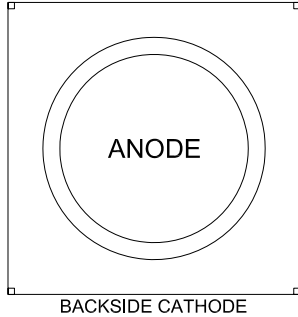

MECHANICAL SPECIFICATIONS:

| | |
|------------------------|------------------|
| Die Size | 15.5 x 15.5 MILS |
| Die Thickness | 8.0 MILS |
| Anode Bonding Pad Size | 10 MILS DIAMETER |
| Top Side Metalization | Ag – 100,000Å |
| Back Side Metalization | Au – 12,000Å |
| Scribe Alley Width | 2.0 MILS |
| Wafer Diameter | 4 INCHES |
| Gross Die Per Wafer | 41,000 |

MAXIMUM RATINGS: ($T_A=25^\circ\text{C}$)

| | SYMBOL | | UNITS |
|---|----------------|-------------|------------------|
| Peak Repetitive Reverse Voltage | V_{RRM} | 30 | V |
| Continuous Forward Current | I_F | 100 | mA |
| Peak Repetitive Forward Current | I_{FRM} | 350 | mA |
| Peak Forward Surge Current, $t_p=10\text{ms}$ | I_{FSM} | 750 | mA |
| Operating and Storage Junction Temperature | T_J, T_{stg} | -65 to +150 | $^\circ\text{C}$ |

ELECTRICAL CHARACTERISTICS: ($T_A=25^\circ\text{C}$ unless otherwise noted)

| SYMBOL | TEST CONDITIONS | MIN | MAX | UNITS |
|----------|---|-----|------|-------|
| I_R | $V_R=25\text{V}$ | | 500 | nA |
| BV_R | $I_R=100\mu\text{A}$ | 30 | | V |
| V_F | $I_F=2.0\text{mA}$ | | 0.33 | V |
| V_F | $I_F=15\text{mA}$ | | 0.45 | V |
| V_F | $I_F=100\text{mA}$ | | 1.0 | V |
| C_J | $V_R=0, f=1.0\text{MHz}$ | | 20 | pF |
| t_{rr} | $I_F=I_R=10\text{mA}, I_{rr}=1.0\text{mA}, R_L=100\Omega$ | | 5.0 | ns |

CPD35-CMP SH-3

Typical Electrical Characteristics

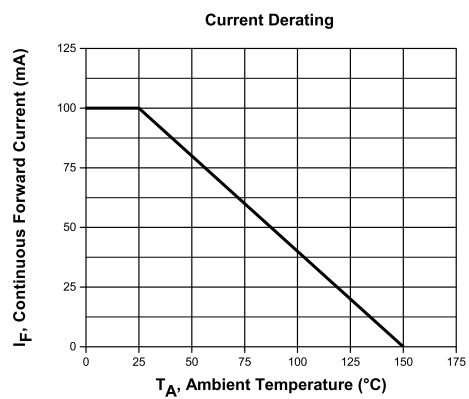
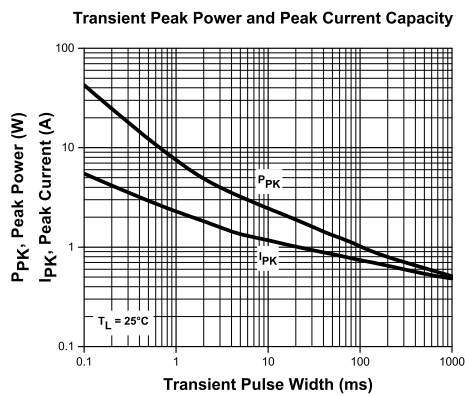
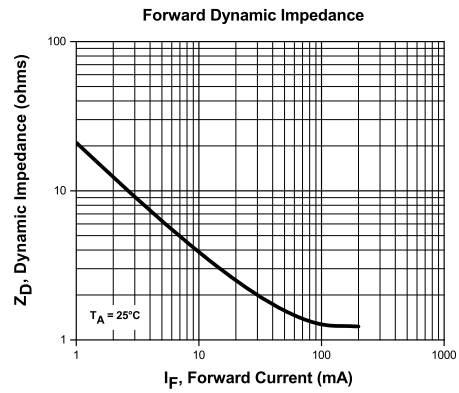
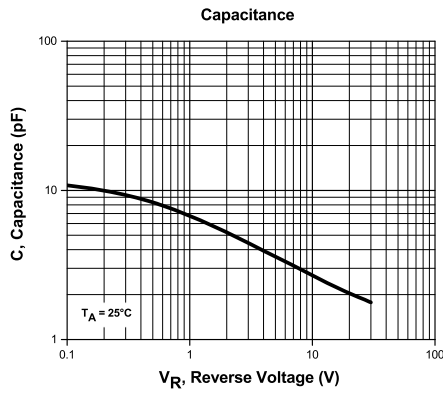
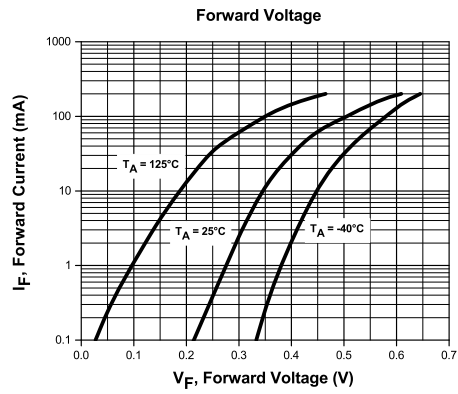
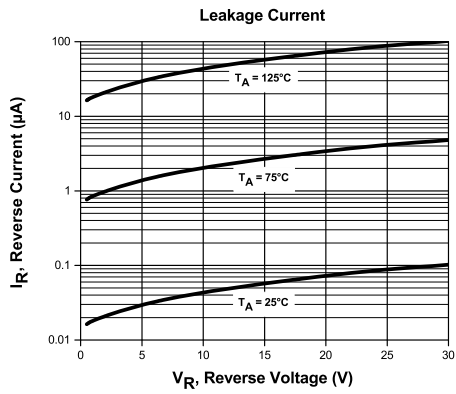

BARE DIE PACKING OPTIONS



BARE DIE IN TRAY (WAFFLE) PACK

CT: Singulated die in tray (waffle) pack.
(example: CP211-PART NUMBER-CT)

CM: Singulated die in tray (waffle) pack 100% visually inspected as per MIL-STD-750, (method 2072 transistors, method 2073 diodes).
(example: CP211-PART NUMBER-CM)



UNSAWN WAFER

WN: Full wafer, unsawn, 100% tested with reject die inked.
(example: CP211-PART NUMBER-WN)



SAWN WAFER ON PLASTIC RING

WR: Full wafer, sawn and mounted on plastic ring,
100% tested with reject die inked.
(example: CP211-PART NUMBER-WR)

Please note: Sawn Wafer on Metal Frame (WS) is possible as a special order. Please contact your Central Sales Representative at 631-435-1110.

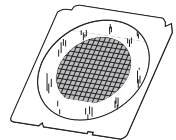

Visit the Central website for a complete listing of specifications:
www.centrasemi.com/bdspecs

OUTSTANDING SUPPORT AND SUPERIOR SERVICES



PRODUCT SUPPORT

Central's operations team provides the highest level of support to insure product is delivered on-time.

- Supply management (Customer portals)
- Inventory bonding
- Consolidated shipping options
- Custom bar coding for shipments
- Custom product packing

DESIGNER SUPPORT/SERVICES

Central's applications engineering team is ready to discuss your design challenges. Just ask.

- Free quick ship samples (2nd day air)
- Online technical data and parametric search
- SPICE models
- Custom electrical curves
- Environmental regulation compliance
- Customer specific screening
- Up-screening capabilities
- Special wafer diffusions
- PbSn plating options
- Package details
- Application notes
- Application and design sample kits
- Custom product and package development

REQUESTING PRODUCT PLATING

1. If requesting Tin/Lead plated devices, add the suffix "TIN/LEAD" to the part number when ordering (example: 2N2222A TIN/LEAD).
2. If requesting Lead (Pb) Free plated devices, add the suffix "PBFREE" to the part number when ordering (example: 2N2222A PBFREE).

CONTACT US

Corporate Headquarters & Customer Support Team

Central Semiconductor Corp.
145 Adams Avenue
Hauppauge, NY 11788 USA
Main Tel: (631) 435-1110
Main Fax: (631) 435-1824
Support Team Fax: (631) 435-3388
www.centrasemi.com

Worldwide Field Representatives:
www.centrasemi.com/wwreps

Worldwide Distributors:
www.centrasemi.com/wwdistributors

For the latest version of Central Semiconductor's **LIMITATIONS AND DAMAGES DISCLAIMER**, which is part of Central's Standard Terms and Conditions of sale, visit: www.centrasemi.com/terms

Product End of Life Notification

| | |
|--------------------|----------|
| PDN ID: | PDN00999 |
| Notification Date: | 8/03/15 |
| Last Buy Date: | Varies |
| Last Shipment Date | Varies |

Summary: The purpose of this End of Life Notification is to identify the bare die devices that Central previously discontinued without notification. This list excludes standard packaged and custom devices. The discontinuance of these devices predates Central's current EOL notification process. The notification process now utilized by Central is industry standard and all future product discontinuation notifications will be issued accordingly. We apologize for any inconvenience caused.

Although Central Semiconductor Corp. makes every effort to continue to produce devices that have been proclaimed EOL (End of Life) by other manufacturers, it is an accepted industry practice to discontinue certain devices when customer demand falls below a minimum level of sustainability. Accordingly, the following product(s) have been transitioned to End of Life status as part of Central's ongoing Product Management Process. Any replacement products are noted below. The effective date for placing last purchase orders will be six (6) months from the date of this notice and twelve (12) months from the notice date for final shipments, and minimum order quantities may apply. The last purchase and shipment dates may be extended if inventory is available.

*** All Plating types (PBFREE,TIN/LEAD) for each item listed are included in this notice.**

| <u>Central Part Number</u> | <u>Replacement</u> |
|----------------------------|---------------------|
| CPD35-CMP SH-3-WN | CPD48V-CMP SH-3-WN |
| CPD41-1N3600-WN | N/A, Stock Only |
| CPD41-1N4148-CT | N/A, Stock Only |
| CPD41-1N4150-CT | N/A, Stock Only |
| CPD42-CMR1-06-WN | CPD69-CMR1-06M-WN |
| CPD42-CMR1-10-WN | CPD69-1N4007-WN |
| CPD63-1N4148-CT | CPD83V-1N4148-CT |
| CPD63-1N4148-CTAN | CPD83V-1N4148-CTAN |
| CPD63-1N4148-WN | CPD83V-1N4148-WN |
| CPD63-1N4148-WS | CPD83V-1N4148-WS |
| CPD63-1N4448-WN | CPD83V-1N4448-WN |
| CPD63-1N4454-CT | CPD83V-1N4454-CT |
| CPD63-1N914-CT | CPD83V-1N914-CT |
| CPD63-1N914-WN | CPD83V-1N914-WN |
| CPD63-1N914-WR | CPD83V-1N914-WR |
| CPD63-1N914A-WN | CPD83V-1N914A-WN |
| CPD64-CLL459A-CT | CPD66X-CLL459A-CT |
| CPD64-CMPD3003-CT | CPD66X-CMPD3003-CT |
| CPD64-CMPD3003-WN | CPD66X-CMPD3003-WN |
| CPD64-1N3595-CT | CPD66X-1N3595-CT |
| CPD64-1N3595-WN | CPD66X-1N3595-WN |
| CPD64-1N3595-WR | CPD66X-1N3595-WR |
| CPD64-1N485B-CT | CPD66X-1N485B-CT |
| CPD73-CMFBR-6F-WN | N/A, Stock Only |
| CPD77-1N5820-WN | CPD77X-1N5820-WN |
| CPD81-CZSH5-40-CT | CPD81X-CZSH5-40-CT |
| CPD86X-CZSH5-40-CT | CPD81X-CZSH5-40-CT |
| CPD92-CMPD6263-CT | CPD102X-CMPD6263-CT |
| CPD92-CMUD6263E-CT | CPD102X-6263E-CT |
| CPD92X-CMPD6263-WR | CPD102X-CMPD6263-WR |
| CPD99-MBR1645-CT | N/A, Stock Only |
| CPZ18-CMOZ3L9-CT | CPZ28X-CMOZ3L9-CT |

*** CONTINUED ***

DISCLAIMER: This End of Life (EOL) notification is in accordance with JEDEC standard JESD48 - Product Discontinuance. Central Semiconductor Corp. will make every effort to offer life-time buy (LTB) opportunities and/or offer replacement devices to existing customers for discontinued devices, however, one or both may not be possible for all devices. Please contact your local Central Semiconductor sales representative for LTB opportunities/additional information.

Product End of Life Notification

| | |
|--------------------|----------|
| PDN ID: | PDN00999 |
| Notification Date: | 8/03/15 |
| Last Buy Date: | Varies |
| Last Shipment Date | Varies |

*** CONTINUED FROM PRIOR PAGE ***

* All Plating types (PBFREE,TIN/LEAD) for each item listed are included in this notice.

| Central Part Number | Replacement |
|---------------------|---------------------|
| CPZ18-CMPZ4626-CT | CPZ28X-1N4626-CT |
| CPZ18-CMPZ4626-WN | CPZ28X-CMPZ4626-WN |
| CPZ18-CMPZ5231B-CT | CPZ28X-CMPZ5231B-CT |
| CPZ18-CMPZ5232B-CT | CPZ28X-1N5232B-CT |
| CPZ18-1N4622-CT | CPZ28X-1N4622-CT |
| CPZ18-1N4626-WN | CPZ28X-CMPZ4626-WN |
| CPZ18-1N5231B-CT | CPZ28X-CMPZ5231B-CT |
| CPZ18-1N5232B-CT | CPZ28X-1N5232B-CT |
| CPZ18-1N5232B-CTAN | CPZ28X-1N5232B-CT |
| CPZ18-1N5524B-CT | CPZ28X-1N5524B-CT |
| CPZ18-1N751A-CT | CPZ28X-1N751A-CT |
| CPZ18-1N752A-CT | N/A, Stock Only |
| CPZ19-BZX84C39-CT | N/A, Stock Only |
| CPZ19-BZX84C8V2-WN | N/A, Stock Only |
| CPZ19-CMPZ5236B-CT | CPZ28X-CMPZ5236B-CT |
| CPZ19-CMPZ5241B-WN | N/A, Stock Only |
| CPZ19-CMPZ5244B-CT | CPZ28-CMPZ5244B-CT |
| CPZ19-CMPZ5246B-WN | N/A, Stock Only |
| CPZ19-CMPZ5254B-WN | CPZ28X-CMPZ5254B-WN |
| CPZ19-CMPZ5258B-CT | N/A, Stock Only |
| CPZ19-CMPZ5258B-WN | N/A, Stock Only |
| CPZ19-1N4753A-WN | CPZ25-1N4753A-WN |
| CPZ19-1N5236B-CT200 | CPZ28X-5236B-CT200 |
| CPZ19-1N5244B-CT | CPZ28X-1N5244B-CT |
| CPZ19-1N5258B-WN | N/A, Stock Only |
| CPZ19-1N6001B-CT | CPZ28-1N6001B-CT |
| CPZ19-1N6001B-WN | CPZ28-1N6001B-WN |
| CPZ28-BZX84C39-WR | CPZ28X-BZX84C39-WR |
| CP108-CRSH2-4-CT | N/A, Stock Only |
| CP108-CRSH2-5-CT | N/A, Stock Only |
| CP108-1N5819-CT | N/A, Stock Only |
| CP117-TIP112-CT | CP230-TIP122-CT |
| CP117-TIP121-CT | CP230-TIP122-CT |
| CP117-2N6045-CT | CP127-2N6045-CT |
| CP117-2N6300-CT | CP127-2N6300-CT |
| CP117-2N6301-CT | CP127-2N6301-CT |
| CP117-2N6301-WS | CP127-2N6301-WS |
| CP142-2N4240-CT | CP212-2N4240-CT |
| CP160-MPSA42-CT | CP310-MPSA42-CT |
| CP169-2N5179-WN | N/A, Stock Only |
| CP177-TIP50-WN | N/A, Stock Only |
| CP183-2N5320-CT | CP325V-2N5320-CT |
| CP188-BCW72-CT | N/A, Stock Only |

*** CONTINUED ***

DISCLAIMER: This End of Life (EOL) notification is in accordance with JEDEC standard JESD48 - Product Discontinuance. Central Semiconductor Corp. will make every effort to offer life-time buy (LTB) opportunities and/or offer replacement devices to existing customers for discontinued devices, however, one or both may not be possible for all devices. Please contact your local Central Semiconductor sales representative for LTB opportunities/additional information.

Product End of Life Notification

| | |
|--------------------|----------|
| PDN ID: | PDN00999 |
| Notification Date: | 8/03/15 |
| Last Buy Date: | Varies |
| Last Shipment Date | Varies |

*** CONTINUED FROM PRIOR PAGE ***

* All Plating types (PBFREE,TIN/LEAD) for each item listed are included in this notice.

| <u>Central Part Number</u> | <u>Replacement</u> |
|----------------------------|--------------------|
| CP188-BC237B-CT | N/A, Stock Only |
| CP188-CMPT5089-CT | CP388X-2N5089-CT |
| CP188-CMPT5089-WN | N/A, Stock Only |
| CP188-2N2484-CT | CP388X-2N2484-CT |
| CP188-2N2484-WN | CP388X-2N2484-WN |
| CP188-2N2920-CTJ | N/A, Stock Only |
| CP188-2N5088-CTO | CP388X-2N5088-CT |
| CP188V-BCX70K-WR | CP388X-BCX70K-WR |
| CP188V-2N5088-CT | CP388X-2N5088-CT |
| CP191-2N2219A-CT | N/A, Stock Only |
| CP191-2N2222A-CT | CP191V-2N2222A-CT |
| CP191-2N2222A-WN | CP191V-2N2222A-WN |
| CP191-2N2222A-WR | CP191V-2N2222A-WR |
| CP191-2N2222A-WS | CP191V-2N2222A-WR |
| CP195-2N3501-CT | CP318V-2N3501-CT |
| CP195-2N3501-WN | CP318V-2N3501-WN |
| CP195-2N5682-CT | CP318V-2N5682-CT |
| CP195-2N5682-WN | CP318V-2N5682-WN |
| CP207-2N2369A-CT | CP396V-2N2369A-CT |
| CP207-2N2369A-WN | CP396V-2N2369A-WN |
| CP237-2N3725-CT | CP337V-2N3725-WN |
| CP301-2N3439-CT | CP310-2N3439-CT |
| CP303V-CMPT8099-CT | CP303X-CMPT8099-CT |
| CP303V-CMPT8099-WN | CP303X-CMPT8099-WN |
| CP305-MJE182-CT | CP325V-MJE182-CT |
| CP314-MPS650-CT | CP314V-MPS650-CT |
| CP316-2N5551-CT | CP336V-2N5551-CT |
| CP316V-2N5551-CT | CP336V-2N5551-CT |
| CP316V-2N5551-CTAN | N/A, Stock Only |
| CP316V-2N5551-WN | CP336V-2N5551-WN |
| CP317-2N2857-CT | N/A, Stock Only |
| CP317-2N918-CT | N/A, Stock Only |
| CP319-CZTA44HC-CT | CP212-CZTA44HC-CT |
| CP319-TIP47-CT | CP212-TIP47-CT |
| CP319-TIP50-CT | CP212-TIP50-CT |
| CP324-2N7002-CM | N/A, Stock Only |
| CP324-2N7002-CT | N/A, Stock Only |
| CP324-2N7002-WN | N/A, Stock Only |
| CP336V-2N5551-CTAN | CP336V-2N5551-CT |
| CP353-2N3506-CT | CP353V-2N3506-CT |
| CP512-2N4033-CT | CP705V-CZT4033-CT |
| CP512-2N4033-WN | CP705V-CZT4033-WN |
| CP517-BDX54C-WS | CP527-BDX54C-WR |

*** CONTINUED ***

DISCLAIMER: This End of Life (EOL) notification is in accordance with JEDEC standard JESD48 - Product Discontinuance. Central Semiconductor Corp. will make every effort to offer life-time buy (LTB) opportunities and/or offer replacement devices to existing customers for discontinued devices, however, one or both may not be possible for all devices. Please contact your local Central Semiconductor sales representative for LTB opportunities/additional information.

Product End of Life Notification

| | |
|--------------------|----------|
| PDN ID: | PDN00999 |
| Notification Date: | 8/03/15 |
| Last Buy Date: | Varies |
| Last Shipment Date | Varies |

*** CONTINUED FROM PRIOR PAGE ***

* All Plating types (PBFREE,TIN/LEAD) for each item listed are included in this notice.

| Central Part Number | Replacement |
|---------------------|---------------------|
| CP517-TIP126-CT | CP630-TIP127-CT |
| CP517-2N6042-CT | CP527-2N6042-CT |
| CP517-2N6053-CM | CP527-2N6053-CM |
| CP517-2N6053-CT | CP527-2N6053-CT |
| CP517-2N6296-CT | CP527-2N6296-CT |
| CP517-2N6299-CT | CP527-2N6299-CT |
| CP517-2N6299-WS | CP527-2N6299-WR |
| CP517-2N6668-CT | CP527-2N6668-CT |
| CP529-CMPT2907A-WN | N/A, Stock Only |
| CP548-2N5116-WN | N/A, Stock Only |
| CP555-2N4209-WN | CP742X-CM4209-WN |
| CP559-2N2907A-WN | N/A, Stock Only |
| CP560-MPSA92-CT | CP710V-MPSA92-CT |
| CP560-MPSA92-WN | CP710V-MPSA92-WN |
| CP560-2N6520-WN | CP710V-2N6520-WN |
| CP584-2N5401-CTAN | N/A, Stock Only |
| CP584-2N5401-WN | N/A, Stock Only |
| CP587-2N3964-WN | N/A, Stock Only |
| CP588-BCW70-CT | CP788X-BCW70-CT |
| CP588-2N3799-WN | CP788X-2N3799-CT |
| CP588-2N5087-CT | N/A, Stock Only |
| CP588V-BC556B-WR | N/A, Stock Only |
| CP588V-2N2605-CT | CP788X-2N2605-CT |
| CP588V-2N3799-WN | N/A, Stock Only |
| CP588V-2N5087-CT | CP788X-2N5087-CT |
| CP591-2N2907A-CT | CP591X-2N2907A-CT |
| CP591V-2N2907A-CT | CP591X-2N2907A-CT |
| CP592-CMPT3906-CT | CP792V-CMPT3906-CT |
| CP592-2N3251-CT | CP792V-2N3251-CT |
| CP592-2N3906-WN | CP792V-2N3906-WN |
| CP701-2N5416-CT | CP710V-2N5416-CT |
| CP705-BC327-25-CT | N/A, Stock Only |
| CP705-BC327-40-CT | N/A, Stock Only |
| CP705-BC807-40-CT | N/A, Stock Only |
| CP705-BD140-CT | N/A, Stock Only |
| CP705-CZT4033-CT | CP705V-CZT4033-CT |
| CP705-D41D11-CT | CP705V-D41D11-CT |
| CP705-D41D11-CT200 | CP705V-D41D11-CT200 |
| CP705-2N4356-CT | N/A, Stock Only |
| CP705-2N4356-WN | N/A, Stock Only |
| CP707-MPSA64-WN | CP727V-MPSA64-WN |
| CP707-MPSU95-CT | CP727V-MPSU95-CT |
| CP710-CMPTA94-CT | CP710V-CMPTA94-CT |

*** CONTINUED ***

DISCLAIMER: This End of Life (EOL) notification is in accordance with JEDEC standard JESD48 - Product Discontinuance. Central Semiconductor Corp. will make every effort to offer life-time buy (LTB) opportunities and/or offer replacement devices to existing customers for discontinued devices, however, one or both may not be possible for all devices. Please contact your local Central Semiconductor sales representative for LTB opportunities/additional information.

Product End of Life Notification

| | |
|---------------------------|----------|
| PDN ID: | PDN00999 |
| Notification Date: | 8/03/15 |
| Last Buy Date: | Varies |
| Last Shipment Date | Varies |

*** CONTINUED FROM PRIOR PAGE ***

*** All Plating types (PBFREE,TIN/LEAD) for each item listed are included in this notice.**

| <u>Central Part Number</u> | <u>Replacement</u> |
|----------------------------|--------------------|
| CP710-MJE350-CT | N/A, Stock Only |
| CP710-MPSA92-CT | CP710V-MPSA92-CT |
| CP714-MPS750-CT | CP714V-MPS750-CT |
| CP714-MPS751-CT | N/A, Stock Only |
| CP714-MPS751-WN | N/A, Stock Only |
| CP716-CMPT5401-CM | N/A, Stock Only |
| CP716-CMPT5401-CT | N/A, Stock Only |
| CP716-2N5401-CTAN | N/A, Stock Only |
| CP716V-CMPT5401-CM | N/A, Stock Only |
| CP716V-2N3635-CM | CP736V-2N3635-CM |
| CP716V-2N3635-CT | CP736V-2N3635-CT |
| CP716V-2N5401-CT | CP736V-2N5401-CT |
| CP716V-2N5401-CTAN | CP736V-2N5401-CTAN |
| CP716V-2N5401-WN | CP736V-2N5401-WN |
| CP792V-2N3906-CT | CP792V-CMPT3906-CT |

Central would be happy to assist you by providing additional information or technical data to help locate an alternate source if we have no replacement available. Please email your requests to engineering@centrasemi.com.

DISCLAIMER: This End of Life (EOL) notification is in accordance with JEDEC standard JESD48 - Product Discontinuance. Central Semiconductor Corp. will make every effort to offer life-time buy (LTB) opportunities and/or offer replacement devices to existing customers for discontinued devices, however, one or both may not be possible for all devices. Please contact your local Central Semiconductor sales representative for LTB opportunities/additional information.