

CRU24730-600

**SILICON HYPER-FAST
RECOVERY RECTIFIER DIODE**



TO-247 CASE



www.centrasemi.com

DESCRIPTION:

The CENTRAL SEMICONDUCTOR CRU24730-600 is an hyper-fast recovery diode, manufactured in the TO-247 case, designed for high current switching applications. Designed for use with SuperJunction MOSFETs.

**MARKING: CRU247
30-600**

APPLICATIONS:

- Flyback diode configurations
- DC/DC converters
- Switch-mode power supplies

FEATURES:

- Dual diode configuration
- Fast reverse recovery time
- High current capability

MAXIMUM RATINGS: ($T_C=25^\circ\text{C}$)

	SYMBOL		UNITS
Repetitive Peak Reverse Voltage	V_{RRM}	600	V
DC Blocking Voltage	V_{DC}	600	V
Diode Forward Current ($T_C=130^\circ\text{C}$)	$I_{F(AV)}$	30	A
Diode Forward Current (Both Legs)	$I_{F(AV)}$	60	A
Repetitive Peak Surge Current ($t_p=8.3\text{ms}$)	I_{FRM}	60	A
Peak Surge Current ($t_p=8.3\text{ms}$, half-sine)	I_{FSM}	175	A
Power Dissipation	P_D	125	W
Operating and Storage Junction Temperature	T_J, T_{stg}	-55 to +150	$^\circ\text{C}$

ELECTRICAL CHARACTERISTICS: ($T_J=25^\circ\text{C}$ unless otherwise noted)

SYMBOL	TEST CONDITIONS	MIN	TYP	MAX	UNITS
V_F	$I_F=30\text{A}$		1.8	2.5	V
V_F	$I_F=30\text{A}, T_J=125^\circ\text{C}$		1.45		V
I_R	$V_R=600\text{V}$			250	μA
I_R	$V_R=600\text{V}, T_J=125^\circ\text{C}$			1.0	mA
t_{rr}	$I_F=0.5\text{A}, I_R=1\text{A}, I_{RR}=0.25\text{A}$			45	ns
t_{rr}	$I_F=1\text{A}, V_R=30\text{V}, di/dt=300\text{A}/\mu\text{s}$			35	ns

CRU24730-600

SILICON HYPER-FAST
RECOVERY RECTIFIER DIODE



TO-247 CASE - MECHANICAL OUTLINE

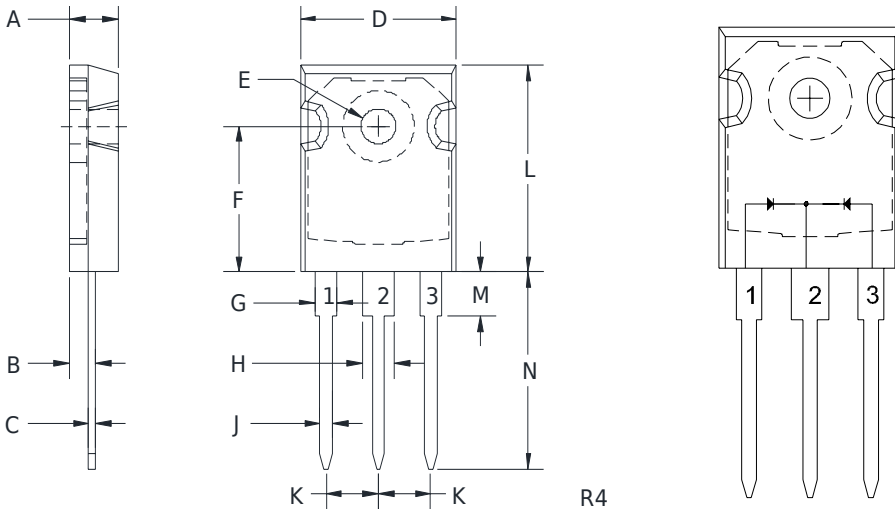

LEAD CODE:

- 1) D1 Anode
- 2) Common Cathode
- 3) D2 Anode
- Pad) Common Cathode

MARKING:

CRU247

30-600

DIMENSIONS				
SYMBOL	INCHES		MILLIMETERS	
	MIN	MAX	MIN	MAX
A	0.184	0.211	4.68	5.36
B	0.087	0.110	2.20	2.80
C	0.019	0.028	0.48	0.70
D	0.606	0.638	15.38	16.20
E (DIA)	0.128	0.144	3.25	3.65
F	0.583	0.607	14.81	15.42
G	0.072	0.097	1.82	2.46
H	0.114	0.133	2.91	3.39
J	0.035	0.060	0.89	1.53
K	0.207	0.223	5.26	5.66
L	0.812	0.881	20.63	22.38
M	0.145	0.177	3.68	4.50
N	0.728	0.846	18.50	21.50

TO-247 (REV: R4)

CRU24730-600

SILICON HYPER-FAST RECOVERY RECTIFIER DIODE



TYPICAL ELECTRICAL CHARACTERISTICS (PER DIODE)

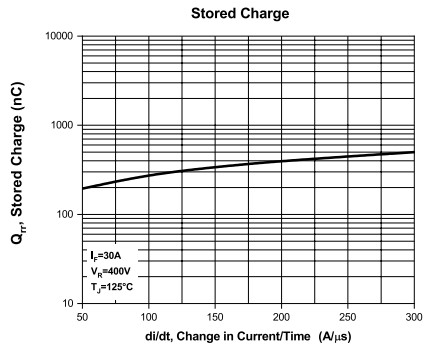
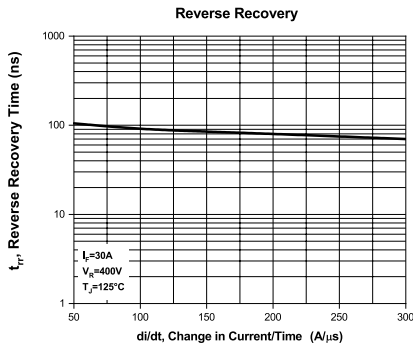
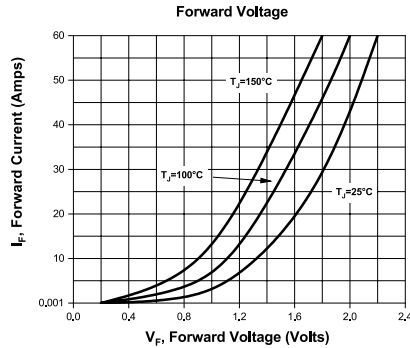
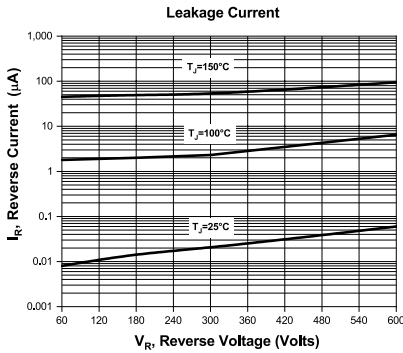
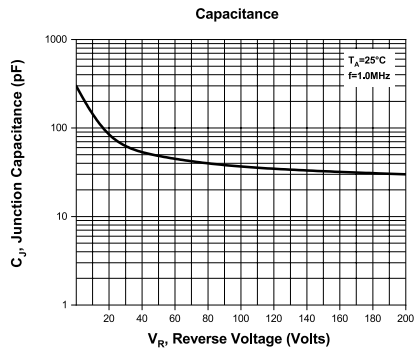
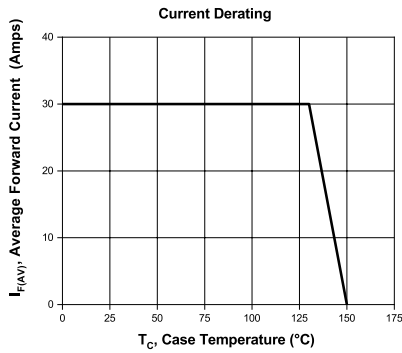

R3 (10-August 2023)

OUTSTANDING SUPPORT AND SUPERIOR SERVICES



PRODUCT SUPPORT

Central's operations team provides the highest level of support to insure product is delivered on-time.

- Supply management (Customer portals)
- Inventory bonding
- Consolidated shipping options
- Custom bar coding for shipments
- Custom product packing

DESIGNER SUPPORT/SERVICES

Central's applications engineering team is ready to discuss your design challenges. Just ask.

- Free quick ship samples (2nd day air)
- Online technical data and parametric search
- SPICE models
- Custom electrical curves
- Environmental regulation compliance
- Customer specific screening
- Up-screening capabilities
- Special wafer diffusions
- PbSn plating options
- Package details
- Application notes
- Application and design sample kits
- Custom product and package development

REQUESTING PRODUCT PLATING

1. If requesting Tin/Lead plated devices, add the suffix "TIN/LEAD" to the part number when ordering (example: 2N2222A TIN/LEAD).
2. If requesting Lead (Pb) Free plated devices, add the suffix "PBFREE" to the part number when ordering (example: 2N2222A PBFREE).

CONTACT US

Corporate Headquarters & Customer Support Team

Central Semiconductor Corp.
145 Adams Avenue
Hauppauge, NY 11788 USA
Main Tel: (631) 435-1110
Main Fax: (631) 435-1824
Support Team Fax: (631) 435-3388
www.centrasemi.com

Worldwide Field Representatives:
www.centrasemi.com/wwreps

Worldwide Distributors:
www.centrasemi.com/wwdistributors

For the latest version of Central Semiconductor's **LIMITATIONS AND DAMAGES DISCLAIMER**, which is part of Central's Standard Terms and Conditions of sale, visit: www.centrasemi.com/terms