

CZSH6-100C

**SURFACE MOUNT SILICON
DUAL, COMMON CATHODE
SCHOTTKY POWER RECTIFIER
6.0 AMP, 100 VOLT**

**SOT-223 CASE**www.centrasemi.com**DESCRIPTION:**

The CENTRAL SEMICONDUCTOR CZSH6-100C is manufactured with two 3.0 Amp Schottky rectifiers assembled in a common cathode configuration and packaged in a SOT-223 case. This device has been designed for high voltage applications requiring a low forward voltage drop.

MARKING: FULL PART NUMBER**MAXIMUM RATINGS:** ($T_A=25^\circ\text{C}$ unless otherwise noted)

	SYMBOL		UNITS
Peak Repetitive Reverse Voltage	V_{RRM}	100	V
DC Blocking Voltage	V_R	100	V
RMS Reverse Voltage	$V_{R(RMS)}$	70	V
Average Forward Current ($T_A=75^\circ\text{C}$)	I_O	6.0	A
Peak Forward Surge Current, $t_p=8.3\text{ms}$	I_{FSM}	75	A
Operating and Storage Junction Temperature	T_J, T_{stg}	-65 to +150	$^\circ\text{C}$
Thermal Resistance	θ_{JA}	62.5	$^\circ\text{C/W}$

ELECTRICAL CHARACTERISTICS PER DIODE: ($T_A=25^\circ\text{C}$ unless otherwise noted)

SYMBOL	TEST CONDITIONS	MAX	UNITS
I_R	$V_R=100\text{V}$	10	μA
I_R	$V_R=100\text{V}, T_A=100^\circ\text{C}$	20	mA
V_F	$I_F=1.0\text{A}$	0.7	V
V_F	$I_F=3.0\text{A}$	0.8	V
V_F	$I_F=6.0\text{A}$	1.0	V

CZSH6-100C

SURFACE MOUNT SILICON
DUAL, COMMON CATHODE
SCHOTTKY POWER RECTIFIER
6.0 AMP, 100 VOLT



SOT-223 CASE - MECHANICAL OUTLINE

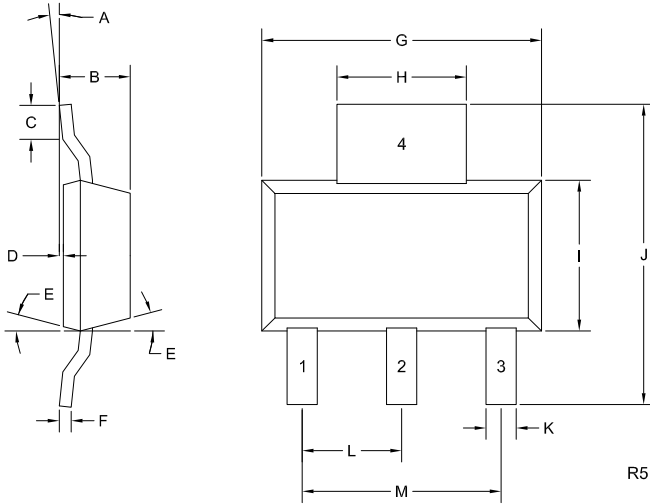

SYMBOL	INCHES		MILLIMETERS	
	MIN	MAX	MIN	MAX
A	0°	10°	0°	10°
B	0.059	0.071	1.50	1.80
C	0.018	--	0.45	--
D	0.000	0.004	0.00	0.10
E	10°		10°	
F	0.009	0.014	0.23	0.35
G	0.248	0.270	6.30	6.85
H	0.114	0.122	2.90	3.10
I	0.130	0.146	3.30	3.70
J	0.264	0.287	6.70	7.30
K	0.024	0.033	0.60	0.85
L	0.091		2.30	
M	0.181		4.60	

SOT-223 (REV: R5)

PIN CONFIGURATION

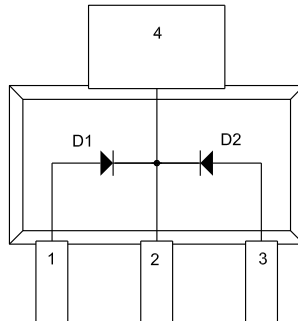

LEAD CODE:

- 1) Anode D1
 - 2) Cathode D1, D2
 - 3) Anode D2
 - 4) Cathode D1, D2
- Pin 2 and Pin 4 are common.

MARKING:

FULL PART NUMBER

R3 (7-May 2019)

CZSH6-100C

**SURFACE MOUNT SILICON
DUAL, COMMON CATHODE
SCHOTTKY POWER RECTIFIER
6.0 AMP, 100 VOLT**



TYPICAL ELECTRICAL CHARACTERISTICS

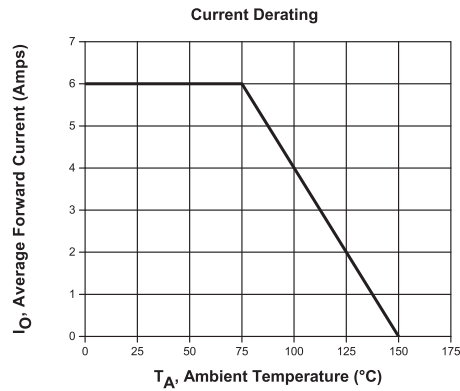
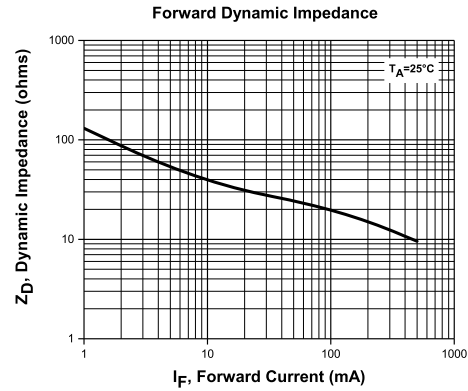
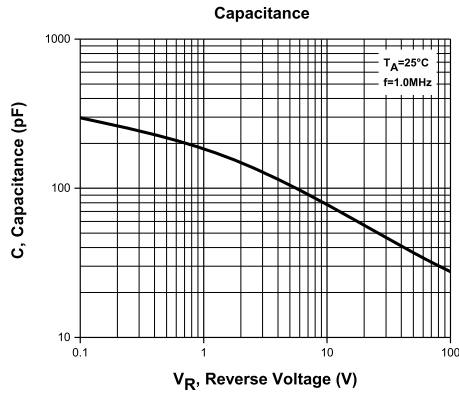
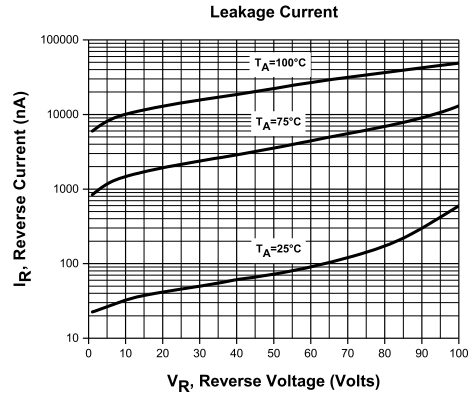
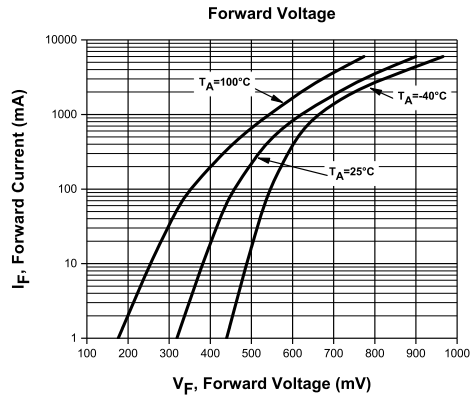

R3 (7-May 2019)

OUTSTANDING SUPPORT AND SUPERIOR SERVICES



PRODUCT SUPPORT

Central's operations team provides the highest level of support to insure product is delivered on-time.

- Supply management (Customer portals)
- Inventory bonding
- Consolidated shipping options
- Custom bar coding for shipments
- Custom product packing

DESIGNER SUPPORT/SERVICES

Central's applications engineering team is ready to discuss your design challenges. Just ask.

- Free quick ship samples (2nd day air)
- Online technical data and parametric search
- SPICE models
- Custom electrical curves
- Environmental regulation compliance
- Customer specific screening
- Up-screening capabilities
- Special wafer diffusions
- PbSn plating options
- Package details
- Application notes
- Application and design sample kits
- Custom product and package development

REQUESTING PRODUCT PLATING

1. If requesting Tin/Lead plated devices, add the suffix "TIN/LEAD" to the part number when ordering (example: 2N2222A TIN/LEAD).
2. If requesting Lead (Pb) Free plated devices, add the suffix "PBFREE" to the part number when ordering (example: 2N2222A PBFREE).

CONTACT US

Corporate Headquarters & Customer Support Team

Central Semiconductor Corp.
145 Adams Avenue
Hauppauge, NY 11788 USA
Main Tel: (631) 435-1110
Main Fax: (631) 435-1824
Support Team Fax: (631) 435-3388
www.centrasemi.com

Worldwide Field Representatives:
www.centrasemi.com/wwreps

Worldwide Distributors:
www.centrasemi.com/wwdistributors

For the latest version of Central Semiconductor's **LIMITATIONS AND DAMAGES DISCLAIMER**, which is part of Central's Standard Terms and Conditions of sale, visit: www.centrasemi.com/terms



https://www.centrasemi.com

Product End of Life Notification

PDN ID:	PDN01275
Notification Date:	2/19/25
Last Buy Date:	8/19/25
Last Shipment Date	2/19/26

Summary: All devices manufactured in the SOT-223 package are discontinued and now classified as End of Life (EOL).

Available options are:

1. Orders will be accepted for products with available inventory.
2. Last Time Buy (LTB) may be available for certain items.
3. A replacement product not available at the time of this notice, may be under development.

Please contact your Central Semiconductor Customer Service Representative at 001.631.435.1110

Although Central Semiconductor makes every effort to continue to produce devices that have been proclaimed EOL (End of Life) by other manufacturers, it is an accepted industry practice to discontinue certain devices when customer demand falls below a minimum level of sustainability. Accordingly, the following product(s) have been transitioned to End of Life status as part of Central's ongoing Product Portfolio Management. Any replacement products are noted below. The effective date for placing last purchase orders will be six (6) months from the date of this notice and twelve (12) months from the notice date for final shipments, and minimum order quantities may apply. The last purchase and shipment dates may be extended if inventory is available.

*** All Plating types (PBFREE,TIN/LEAD) for each item listed are included in this notice.**

<u>Central Part Number</u>	<u>Suggested Replacement</u>
CBCP68 BK	N/A
CBCP68 TR	N/A
CBCP69 BK	N/A
CBCP69 TR	N/A
CEN1038 BK	N/A
CEN1038 TR	N/A
CEN1169 BK	N/A
CEN1169 TR	N/A
CEN1245 TR	N/A
CEN1476 TR	N/A
CQ223-2M BK	N/A
CQ223-2M TR	N/A
CQ223-2N BK	N/A
CQ223-2N TR	N/A
CS223-4M BK	N/A
CS223-4M TR	N/A
CZDM0407P BK	N/A
CZDM0407P TR	N/A
CZDM8502N BK	N/A
CZDM8502N TR	N/A
CZR1-04 BK	N/A
CZR1-04 TR	N/A
CZR1-04C BK	N/A
CZR1-04C TR	N/A
CZSH10-40C BK	N/A
CZSH10-40C TR	N/A
CZSH5-40 BK	N/A
CZSH5-40 TR	N/A
CZSH5-40C BK	N/A
CZSH5-40C TR	N/A
CZSH6-100C BK	N/A

*** CONTINUED ***

DISCLAIMER: This End of Life (EOL) notification is in accordance with JEDEC standard JESD48 - Product Discontinuance. Central Semiconductor will make every effort to offer life-time buy (LTB) opportunities and/or offer replacement devices to existing customers for discontinued devices, however, one or both may not be possible for all devices. Please contact your local Central Semiconductor sales representative for LTB opportunities/additional information.



https://www.centrasemi.com

Product End of Life Notification

PDN ID:	PDN01275
Notification Date:	2/19/25
Last Buy Date:	8/19/25
Last Shipment Date	2/19/26

*** CONTINUED FROM PRIOR PAGE ***

* All Plating types (PBFREE,TIN/LEAD) for each item listed are included in this notice.

Central Part Number	Suggested Replacement
CZSH6-100C TR	N/A
CZS5064 BK	N/A
CZS5064 TR	N/A
CZTA13 BK	N/A
CZTA13 TR	N/A
CZTA14 BK	N/A
CZTA14 TR	N/A
CZTA27 BK	N/A
CZTA27 TR	N/A
CZTA28 BK	N/A
CZTA28 TR	N/A
CZTA42 BK	N/A
CZTA42 TR	N/A
CZTA44 BK	N/A
CZTA44 TR	N/A
CZTA46 BK	N/A
CZTA46 TR	N/A
CZTA64 BK	N/A
CZTA64 TR	N/A
CZTA92 BK	N/A
CZTA92 TR	N/A
CZTA94 BK	N/A
CZTA94 TR	N/A
CZTA96 BK	N/A
CZTA96 TR	N/A
CZT2000 BK	N/A
CZT2000 TR	N/A
CZT2222A BK	N/A
CZT2222A TR	N/A
CZT2222A TR13	N/A
CZT2680 BK	N/A
CZT2680 TR	N/A
CZT2907A BK	N/A
CZT2907A TR	N/A
CZT2955 BK	N/A
CZT2955 TR	N/A
CZT3019 BK	N/A
CZT3019 TR	N/A
CZT3090LE BK	N/A
CZT3090LE TR	N/A
CZT3150 BK	N/A
CZT3150 TR	N/A
CZT3904 BK	N/A

*** CONTINUED ***

DISCLAIMER: This End of Life (EOL) notification is in accordance with JEDEC standard JESD48 - Product Discontinuance. Central Semiconductor will make every effort to offer life-time buy (LTB) opportunities and/or offer replacement devices to existing customers for discontinued devices, however, one or both may not be possible for all devices. Please contact your local Central Semiconductor sales representative for LTB opportunities/additional information.



<https://www.centrasemi.com>

Product End of Life Notification

PDN ID:	PDN01275
Notification Date:	2/19/25
Last Buy Date:	8/19/25
Last Shipment Date	2/19/26

*** CONTINUED FROM PRIOR PAGE ***

* All Plating types (PBFREE,TIN/LEAD) for each item listed are included in this notice.

Central Part Number	Suggested Replacement
CZT3904 TR	N/A
CZT3906 BK	N/A
CZT3906 TR	N/A
CZT4033 BK	N/A
CZT4033 TR	N/A
CZT5338 BK	N/A
CZT5338 TR	N/A
CZT5401 BK	N/A
CZT5401 TR	N/A
CZT5551 BK	N/A
CZT5551 TR	N/A
CZT5551 TR13	N/A
CZT5551E BK	N/A
CZT5551E TR	N/A
CZT5551HC BK	N/A
CZT5551HC TR	N/A
CZT651 BK	N/A
CZT651 TR	N/A
CZT7090LE TR	N/A
CZT751 BK	N/A
CZT751 TR	N/A
CZT853 BK	N/A
CZT853 TR	N/A
CZT953 BK	N/A
CZT953 TR	N/A
CZT955 BK	N/A
CZT955 TR	N/A

Central would be happy to assist you by providing additional information or technical data to help locate an alternate source if we have no replacement available. If you would like assistance, please visit <https://my.centrasemi.com/submit-inquiry?type=ER> to submit an online inquiry.

DISCLAIMER: This End of Life (EOL) notification is in accordance with JEDEC standard JESD48 - Product Discontinuance. Central Semiconductor will make every effort to offer life-time buy (LTB) opportunities and/or offer replacement devices to existing customers for discontinued devices, however, one or both may not be possible for all devices. Please contact your local Central Semiconductor sales representative for LTB opportunities/additional information.