

CMKDM8005

**SURFACE MOUNT SILICON
DUAL P-CHANNEL
ENHANCEMENT-MODE
MOSFET**



www.centrasemi.com



SOT-363 CASE

DESCRIPTION:

The CENTRAL SEMICONDUCTOR CMKDM8005 consists of dual P-Channel enhancement-mode silicon MOSFETs designed for high speed pulsed amplifier and driver applications. These MOSFETs offer very low $r_{DS(ON)}$ and low threshold voltage.

MARKING CODE: C85M

FEATURES:

- ESD protection up to 1800V (Human Body Model)
- 350mW power dissipation
- Very low $r_{DS(ON)}$
- Low threshold voltage
- Logic level compatible
- Small, SOT-363 surface mount package

APPLICATIONS:

- Load switch/Level shifting
- Battery charging
- Boost switch
- Electro-luminescent backlighting

MAXIMUM RATINGS: ($T_A=25^\circ\text{C}$)

Drain-Source Voltage
Gate-Source Voltage
Continuous Drain Current (Steady State)
Continuous Source Current (Body Diode)
Maximum Pulsed Drain Current
Power Dissipation
Operating and Storage Junction Temperature
Thermal Resistance

SYMBOL		UNITS
V_{DS}	20	V
V_{GS}	8.0	V
I_D	650	mA
I_S	250	mA
I_{DM}	1.0	A
P_D	350	mW
T_J, T_{stg}	-65 to +150	$^\circ\text{C}$
Θ_{JA}	357	$^\circ\text{C/W}$

ELECTRICAL CHARACTERISTICS PER TRANSISTOR: ($T_A=25^\circ\text{C}$ unless otherwise noted)

SYMBOL	TEST CONDITIONS	MIN	TYP	MAX	UNITS
I_{GSSF}, I_{GSSR}	$V_{GS}=4.5V, V_{DS}=0$			10	μA
I_{DSS}	$V_{DS}=16V, V_{GS}=0$			100	nA
BV_{DSS}	$V_{GS}=0, I_D=250\mu\text{A}$	20			V
$V_{GS(th)}$	$V_{DS}=V_{GS}, I_D=250\mu\text{A}$	0.5		1.0	V
V_{SD}	$V_{GS}=0, I_S=250\text{mA}$			1.1	V
$r_{DS(ON)}$	$V_{GS}=4.5V, I_D=350\text{mA}$		0.25	0.36	Ω
$r_{DS(ON)}$	$V_{GS}=2.5V, I_D=300\text{mA}$		0.37	0.5	Ω
$r_{DS(ON)}$	$V_{GS}=1.8V, I_D=150\text{mA}$			0.8	Ω
gFS	$V_{DS}=10V, I_D=200\text{mA}$	0.2			S
C_{rss}	$V_{DS}=16V, V_{GS}=0, f=1.0\text{MHz}$		25		pF
C_{iss}	$V_{DS}=16V, V_{GS}=0, f=1.0\text{MHz}$		100		pF
C_{oss}	$V_{DS}=16V, V_{GS}=0, f=1.0\text{MHz}$		21		pF

R3 (3-June 2013)

CMKDM8005

**SURFACE MOUNT SILICON
DUAL P-CHANNEL
ENHANCEMENT-MODE
MOSFET**



ELECTRICAL CHARACTERISTICS PER TRANSISTOR - Continued: ($T_A=25^{\circ}\text{C}$ unless otherwise noted)

SYMBOL	TEST CONDITIONS	TYP	MAX	UNITS
$Q_{g(\text{tot})}$	$V_{DS}=10\text{V}$, $V_{GS}=4.5\text{V}$, $I_D=200\text{mA}$	1.2		nC
Q_{gs}	$V_{DS}=10\text{V}$, $V_{GS}=4.5\text{V}$, $I_D=200\text{mA}$	0.24		nC
Q_{gd}	$V_{DS}=10\text{V}$, $V_{GS}=4.5\text{V}$, $I_D=200\text{mA}$	0.36		nC
t_{on}	$V_{DD}=10\text{V}$, $V_{GS}=4.5\text{V}$, $I_D=200\text{mA}$, $R_G=10\Omega$	38		ns
t_{off}	$V_{DD}=10\text{V}$, $V_{GS}=4.5\text{V}$, $I_D=200\text{mA}$, $R_G=10\Omega$	48		ns

SOT-363 CASE - MECHANICAL OUTLINE

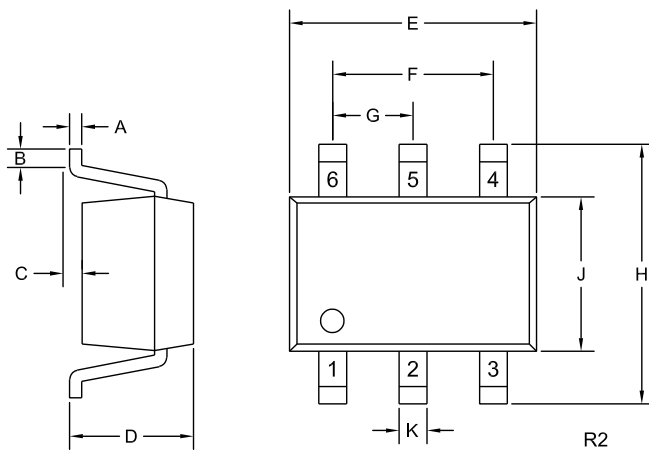

SYMBOL	DIMENSIONS			
	INCHES		MILLIMETERS	
	MIN	MAX	MIN	MAX
A	0.004	0.010	0.10	0.25
B	0.005	-	0.12	-
C	0.000	0.004	0.00	0.10
D	0.031	0.043	0.80	1.10
E	0.071	0.087	1.80	2.20
F	0.051		1.30	
G	0.026		0.65	
H	0.075	0.091	1.90	2.30
J	0.043	0.055	1.10	1.40
K	0.006	0.012	0.15	0.30

SOT-363 (REV: R2)

PIN CONFIGURATION

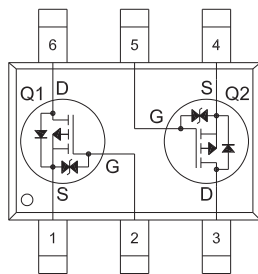

LEAD CODE:

- 1) Source Q1
- 2) Gate Q1
- 3) Drain Q2
- 4) Source Q2
- 5) Gate Q2
- 6) Drain Q1

MARKING CODE: C85M

R3 (3-June 2013)

CMKDM8005

SURFACE MOUNT SILICON
DUAL P-CHANNEL
ENHANCEMENT-MODE
MOSFET



TYPICAL ELECTRICAL CHARACTERISTICS

Output Characteristics

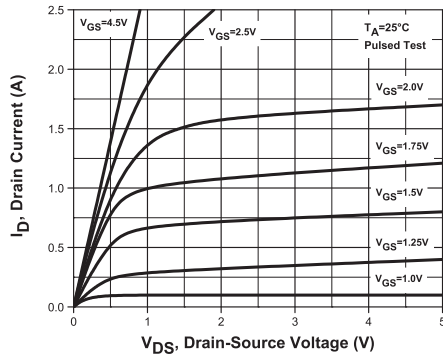

Drain Source On Resistance

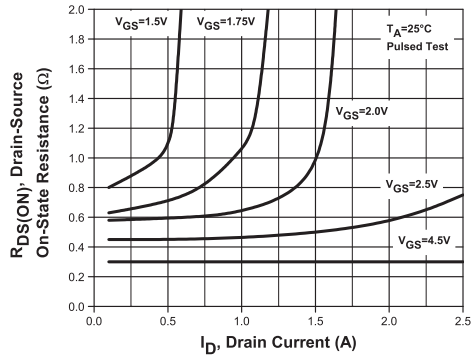

Capacitance

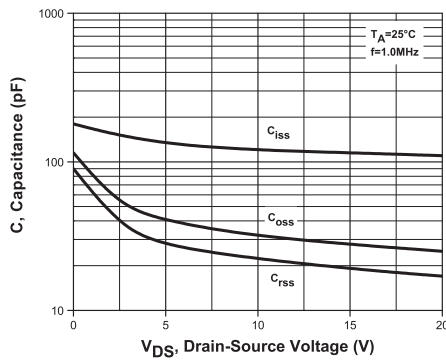

Transfer Characteristics

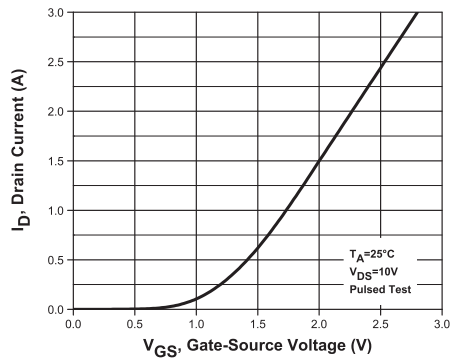

Power Derating

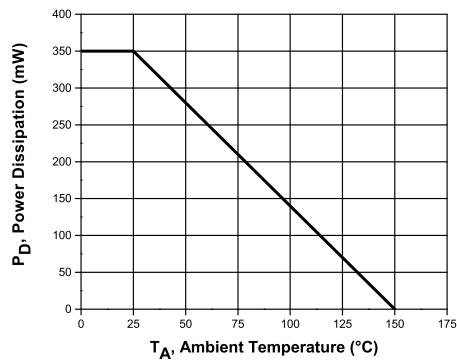

R3 (3-June 2013)

OUTSTANDING SUPPORT AND SUPERIOR SERVICES



PRODUCT SUPPORT

Central's operations team provides the highest level of support to insure product is delivered on-time.

- Supply management (Customer portals)
- Inventory bonding
- Consolidated shipping options
- Custom bar coding for shipments
- Custom product packing

DESIGNER SUPPORT/SERVICES

Central's applications engineering team is ready to discuss your design challenges. Just ask.

- Free quick ship samples (2nd day air)
- Online technical data and parametric search
- SPICE models
- Custom electrical curves
- Environmental regulation compliance
- Customer specific screening
- Up-screening capabilities
- Special wafer diffusions
- PbSn plating options
- Package details
- Application notes
- Application and design sample kits
- Custom product and package development

REQUESTING PRODUCT PLATING

1. If requesting Tin/Lead plated devices, add the suffix " TIN/LEAD" to the part number when ordering (example: 2N2222A TIN/LEAD).
2. If requesting Lead (Pb) Free plated devices, add the suffix " PBFREE" to the part number when ordering (example: 2N2222A PBFREE).

CONTACT US

Corporate Headquarters & Customer Support Team

Central Semiconductor Corp.
145 Adams Avenue
Hauppauge, NY 11788 USA
Main Tel: (631) 435-1110
Main Fax: (631) 435-1824
Support Team Fax: (631) 435-3388
www.centrasemi.com

Worldwide Field Representatives:
www.centrasemi.com/wwreps

Worldwide Distributors:
www.centrasemi.com/wwdistributors

For the latest version of Central Semiconductor's **LIMITATIONS AND DAMAGES DISCLAIMER**, which is part of Central's Standard Terms and Conditions of sale, visit: www.centrasemi.com/terms