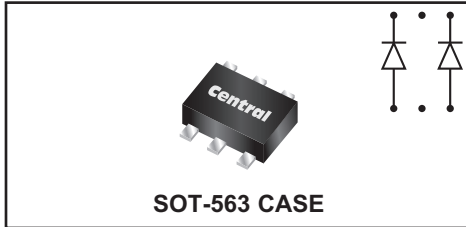

CMLSH-4**SURFACE MOUNT SILICON
DUAL, ISOLATED
SCHOTTKY DIODE**
www.centrasemi.com
DESCRIPTION:

The CENTRAL SEMICONDUCTOR CMLSH-4 are two individual, electrically isolated 40 Volt Schottky diodes in a space saving SOT-563 surface mount package. This device has been designed for applications requiring fast switching speeds and a low forward voltage drop.

MARKING CODES: C4E or 4E**SOT-563 CASE****MAXIMUM RATINGS:** ($T_A=25^\circ\text{C}$)

Peak Repetitive Reverse Voltage
Continuous Forward Current
Peak Repetitive Forward Current
Peak Forward Surge Current, $t_p=10\text{ms}$
Power Dissipation
Operating and Storage Junction Temperature
Thermal Resistance

SYMBOL		UNITS
V_{RRM}	40	V
I_F	200	mA
I_{FRM}	350	mA
I_{FSM}	750	mA
P_D	250	mW
T_J, T_{stg}	-65 to +150	$^\circ\text{C}$
Θ_{JA}	500	$^\circ\text{C/W}$

ELECTRICAL CHARACTERISTICS PER DIODE: ($T_A=25^\circ\text{C}$ unless otherwise noted)

SYMBOL	TEST CONDITIONS	MIN	TYP	MAX	UNITS
I_R	$V_R=25\text{V}$		90	500	nA
I_R	$V_R=25\text{V}, T_A=100^\circ\text{C}$		25	100	μA
BV_R	$I_R=100\mu\text{A}$	40	50		V
V_F	$I_F=2.0\text{mA}$		0.29	0.33	V
V_F	$I_F=15\text{mA}$		0.37	0.42	V
V_F	$I_F=100\text{mA}$		0.51	0.80	V
V_F	$I_F=200\text{mA}$		0.65	1.0	V
C_J	$V_R=1.0\text{V}, f=1.0\text{MHz}$		7.0		pF
t_{rr}	$I_F=I_R=10\text{mA}, I_{rr}=1.0\text{mA}, R_L=100\Omega$			5.0	ns

CMLSH-4
SURFACE MOUNT SILICON
DUAL, ISOLATED
SCHOTTKY DIODE



SOT-563 CASE - MECHANICAL OUTLINE

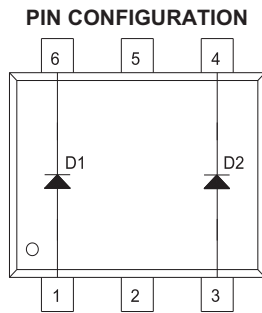
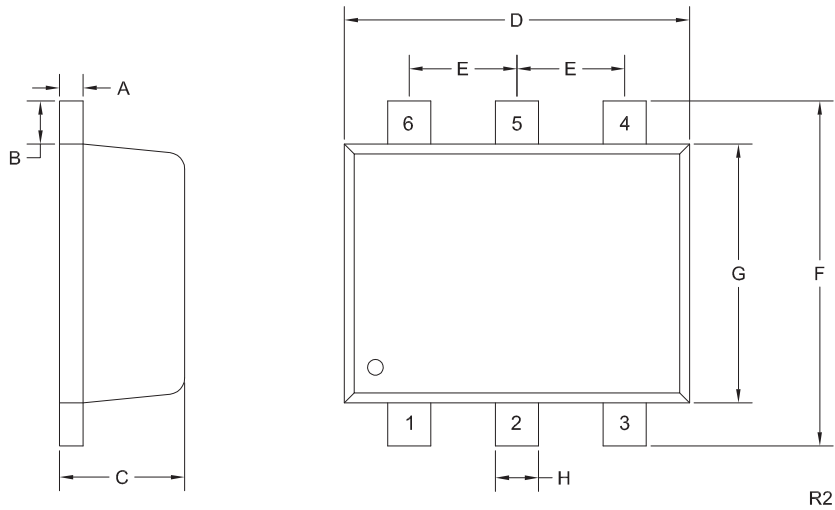

SYMBOL	INCHES		MILLIMETERS	
	MIN	MAX	MIN	MAX
A	0.0027	0.007	0.07	0.18
B	0.008		0.20	
C	0.017	0.024	0.45	0.60
D	0.059	0.067	1.50	1.70
E	0.020		0.50	
F	0.059	0.067	1.50	1.70
G	0.043	0.051	1.10	1.30
H	0.006	0.012	0.15	0.30

SOT-563 (REV: R2)

LEAD CODE:

- 1) Anode D1
- 2) NC
- 3) Anode D2
- 4) Cathode D2
- 5) NC
- 6) Cathode D1

MARKING CODES: C4E or 4E

R5 (16-February 2016)

CMLSH-4
SURFACE MOUNT SILICON
DUAL, ISOLATED
SCHOTTKY DIODE



TYPICAL ELECTRICAL CHARACTERISTICS

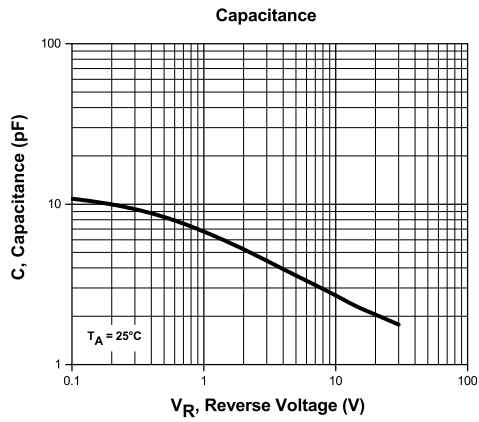
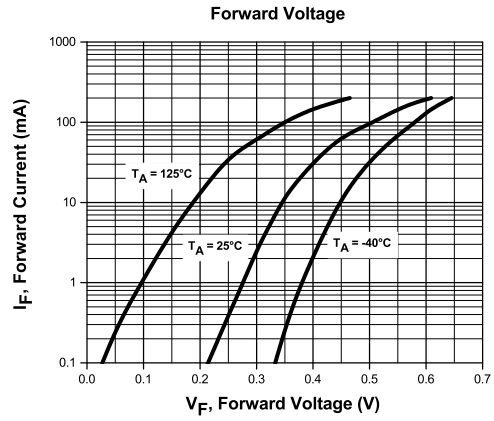
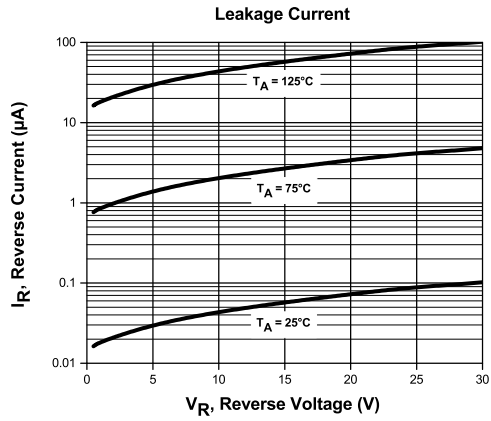

R5 (16-February 2016)

CMLSH-4

SURFACE MOUNT SILICON
DUAL, ISOLATED
SCHOTTKY DIODE



TYPICAL ELECTRICAL CHARACTERISTICS

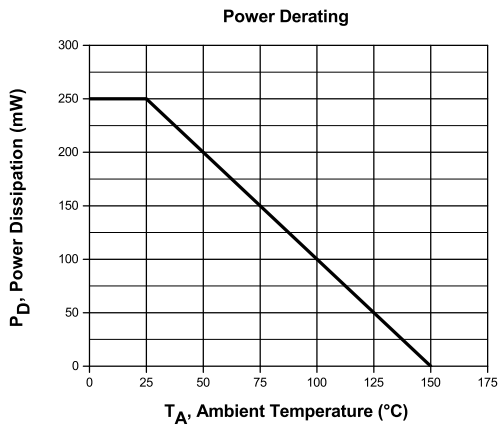
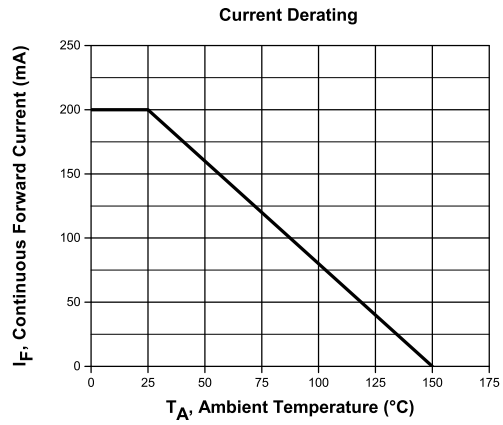
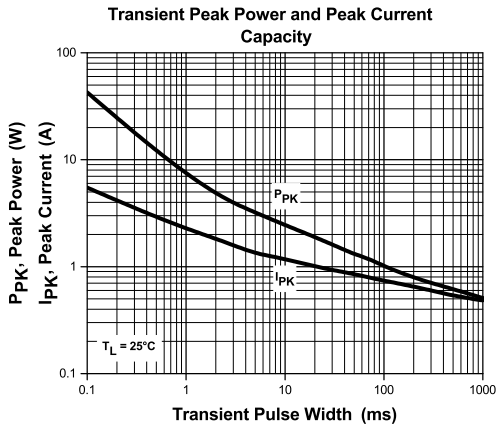

R5 (16-February 2016)

OUTSTANDING SUPPORT AND SUPERIOR SERVICES



PRODUCT SUPPORT

Central's operations team provides the highest level of support to insure product is delivered on-time.

- Supply management (Customer portals)
- Inventory bonding
- Consolidated shipping options
- Custom bar coding for shipments
- Custom product packing

DESIGNER SUPPORT/SERVICES

Central's applications engineering team is ready to discuss your design challenges. Just ask.

- Free quick ship samples (2nd day air)
- Online technical data and parametric search
- SPICE models
- Custom electrical curves
- Environmental regulation compliance
- Customer specific screening
- Up-screening capabilities
- Special wafer diffusions
- PbSn plating options
- Package details
- Application notes
- Application and design sample kits
- Custom product and package development

REQUESTING PRODUCT PLATING

1. If requesting Tin/Lead plated devices, add the suffix " TIN/LEAD" to the part number when ordering (example: 2N2222A TIN/LEAD).
2. If requesting Lead (Pb) Free plated devices, add the suffix " PBFREE" to the part number when ordering (example: 2N2222A PBFREE).

CONTACT US

Corporate Headquarters & Customer Support Team

Central Semiconductor Corp.
145 Adams Avenue
Hauppauge, NY 11788 USA
Main Tel: (631) 435-1110
Main Fax: (631) 435-1824
Support Team Fax: (631) 435-3388
www.centrasemi.com

Worldwide Field Representatives:
www.centrasemi.com/wwreps

Worldwide Distributors:
www.centrasemi.com/wwdistributors

For the latest version of Central Semiconductor's **LIMITATIONS AND DAMAGES DISCLAIMER**, which is part of Central's Standard Terms and Conditions of sale, visit: www.centrasemi.com/terms



<http://www.centrasemi.com>

Product End of Life Notification

PDN ID:	PDN01063 Rev:001
Notification Date:	3/03/17
Last Buy Date:	N/A
Last Shipment Date	N/A

Please be advised that Central Semiconductor must immediately discontinue the product(s) listed in the attached PDN notice. We are unable to accept any further orders for these products **unless** we have available inventory on hand.

You may have purchased one or more of the products listed. Please do not hesitate to contact your local Central Semiconductor sales representative with any questions or needs you may have. Central regrets any inconvenience this may cause.

Sincerely,

Central Semiconductor Corp.

DISCLAIMER: This End of Life (EOL) notification is in accordance with JEDEC standard JESD48 - Product Discontinuance. Central Semiconductor Corp. will make every effort to offer life-time buy (LTB) opportunities and/or offer replacement devices to existing customers for discontinued devices, however, one or both may not be possible for all devices. Please contact your local Central Semiconductor sales representative for LTB opportunities/additional information.

Product End of Life Notification

PDN ID:	PDN01063 Rev:001
Notification Date:	3/03/17
Last Buy Date:	N/A
Last Shipment Date	N/A

Summary: All devices manufactured in the SOT-563 package, using the Option 2 Lead Frame, are discontinued and now classified as End of Life (EOL). Rev001 issued to include BK devices previously excluded in error.

Although Central Semiconductor Corp. makes every effort to continue to produce devices that have been proclaimed EOL (End of Life) by various manufacturers, it is an accepted industry practice to discontinue certain devices when customer demand falls below a minimum level of sustainability. Accordingly, the following product(s) have been transitioned to End of Life status as part of Central's Product Management Process. Any replacement product will be noted below. The effective date for placing the last purchase order will be six(6) months from the date of this notice and twelve(12) months from the notice date for final shipments; this may be extended if inventory is available.

<u>Central Part Number</u>	<u>Replacement</u>
CMLD2004G BK	N/A
CMLD2004G TR	N/A
CMLD4448 BK	N/A
CMLD4448 TR	N/A
CMLD6001 BK	N/A
CMLD6001 TR	N/A
CMLD6263 BK	N/A
CMLD6263 TR	N/A
CMLD6263S BK	N/A
CMLD6263S TR	N/A
CMLSH-4 BK	N/A
CMLSH-4 TR	N/A
CMLZDA3V3 BK	N/A
CMLZDA3V3 TR	N/A
CMLZDA6V2 BK	N/A
CMLZDA6V2 TR	N/A

Central would be happy to assist you by providing additional information or technical data to help locate an alternate source if we have no replacement available. Please email your requests to engineering@centrasemi.com.

DISCLAIMER: This End of Life (EOL) notification is in accordance with JEDEC standard JESD48 - Product Discontinuance. Central Semiconductor Corp. will make every effort to offer life-time buy (LTB) opportunities and/or offer replacement devices to existing customers for discontinued devices, however, one or both may not be possible for all devices. Please contact your local Central Semiconductor sales representative for LTB opportunities/additional information.