

CMOSH-4E

**ENHANCED SPECIFICATION
SURFACE MOUNT SILICON
SCHOTTKY DIODE**



www.centrasemi.com



SOD-523 CASE

DESCRIPTION:

The CENTRAL SEMICONDUCTOR CMOSH-4E is an enhanced version of the CMOSH-3 silicon Schottky diode in an SOD-523 surface mount package.

MARKING CODE: 4E

ENHANCED SPECIFICATIONS:

- ◆ I_F from 100mA MAX to 200mA MAX
- ◆ BV_R from 30V MIN to 40V MIN
- ◆ V_F from 1.0V MAX to 0.8V MAX

MAXIMUM RATINGS: ($T_A=25^\circ\text{C}$)

- ◆ **Peak Repetitive Reverse Voltage**
- ◆ **Continuous Forward Current**
Peak Repetitive Forward Current
Peak Forward Surge Current, $t_p=10\text{ms}$
Power Dissipation
Operating and Storage Junction Temperature
Thermal Resistance

SYMBOL

SYMBOL	UNITS
V_{RRM}	40 V
I_F	200 mA
I_{FRM}	350 mA
I_{FSM}	750 mA
P_D	250 mW
T_J, T_{stg}	-65 to +150 °C
Θ_{JA}	500 °C/W

ELECTRICAL CHARACTERISTICS: ($T_A=25^\circ\text{C}$ unless otherwise noted)

SYMBOL	TEST CONDITIONS	MIN	TYP	MAX	UNITS
I_R	$V_R=25\text{V}$		90	500	nA
I_R	$V_R=25\text{V}, T_A=100^\circ\text{C}$		25	100	μA
◆ BV_R	$I_R=100\mu\text{A}$	40	50		V
V_F	$I_F=2.0\text{mA}$		0.29	0.33	V
◆ V_F	$I_F=15\text{mA}$		0.37	0.42	V
◆ V_F	$I_F=100\text{mA}$		0.51	0.80	V
◆◆ V_F	$I_F=200\text{mA}$		0.65	1.0	V
C_J	$V_R=1.0\text{V}, f=1.0\text{MHz}$		7.0		pF
t_{rr}	$I_F=I_R=10\text{mA}, I_{rr}=1.0\text{mA}, R_L=100\Omega$			5.0	ns

- ◆ Enhanced specification.
- ◆◆ Additional Enhanced specification.

CMOSH-4E

**ENHANCED SPECIFICATION
SURFACE MOUNT SILICON
SCHOTTKY DIODE**



SOD-523 CASE - MECHANICAL OUTLINE

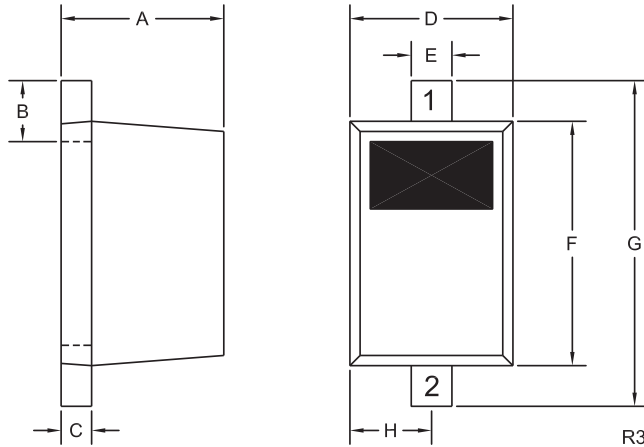

LEAD CODE:

- 1) Cathode
- 2) Anode

MARKING CODE: 4E

DIMENSIONS				
SYMBOL	INCHES		MILLIMETERS	
	MIN	MAX	MIN	MAX
A	0.020	0.031	0.50	0.80
B	0.008	0.016	0.20	0.40
C	0.002	0.008	0.05	0.20
D	0.028	0.035	0.70	0.90
E	0.008	0.014	0.20	0.35
F	0.039	0.055	1.00	1.40
G	0.055	0.071	1.40	1.80
H	0.016		0.40	

SOD-523 (REV: R3)

R5 (16-February 2016)

CMOSH-4E

**ENHANCED SPECIFICATION
SURFACE MOUNT SILICON
SCHOTTKY DIODE**



TYPICAL ELECTRICAL CHARACTERISTICS

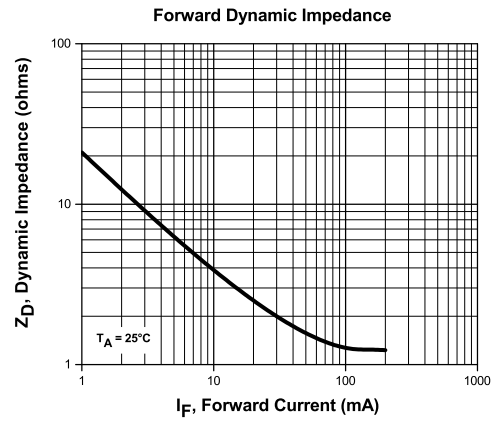
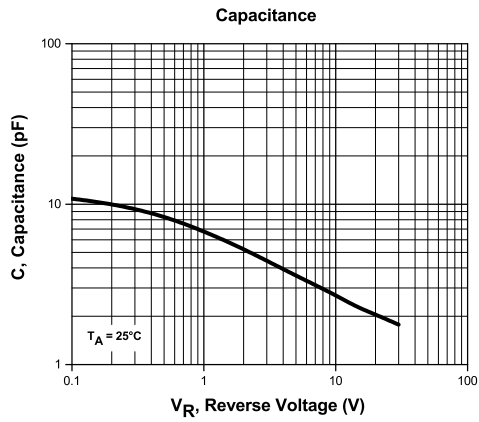
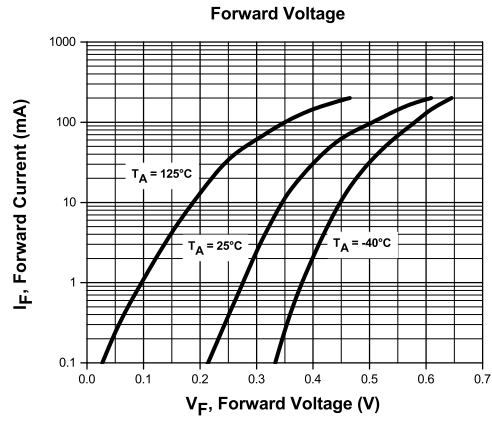
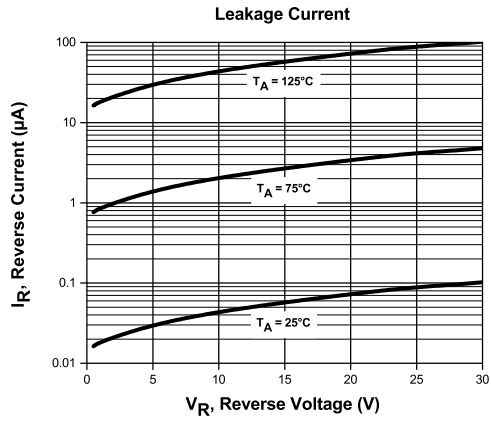

R5 (16-February 2016)

CMOSH-4E

**ENHANCED SPECIFICATION
SURFACE MOUNT SILICON
SCHOTTKY DIODE**



TYPICAL ELECTRICAL CHARACTERISTICS

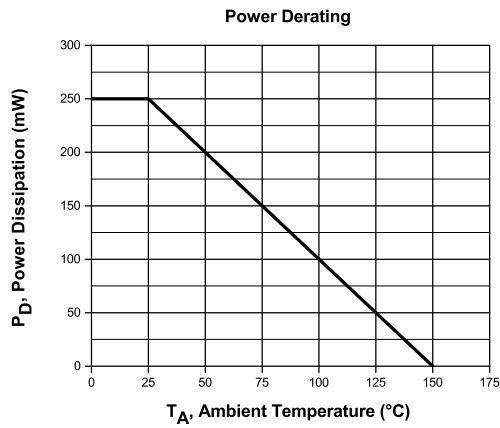
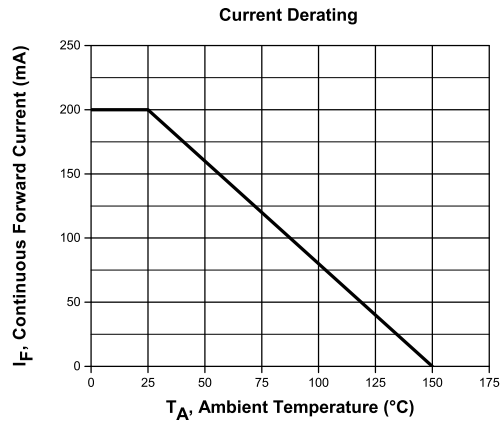
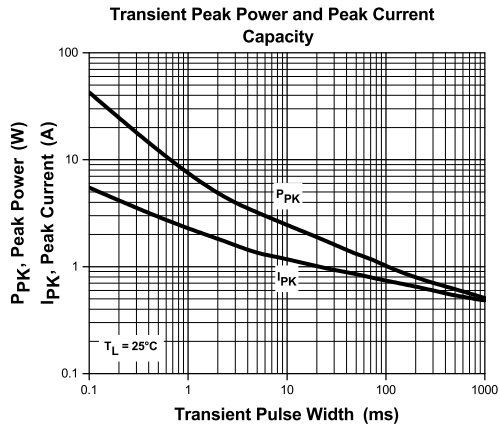

R5 (16-February 2016)

OUTSTANDING SUPPORT AND SUPERIOR SERVICES



PRODUCT SUPPORT

Central's operations team provides the highest level of support to insure product is delivered on-time.

- Supply management (Customer portals)
- Inventory bonding
- Consolidated shipping options
- Custom bar coding for shipments
- Custom product packing

DESIGNER SUPPORT/SERVICES

Central's applications engineering team is ready to discuss your design challenges. Just ask.

- Free quick ship samples (2nd day air)
- Online technical data and parametric search
- SPICE models
- Custom electrical curves
- Environmental regulation compliance
- Customer specific screening
- Up-screening capabilities
- Special wafer diffusions
- PbSn plating options
- Package details
- Application notes
- Application and design sample kits
- Custom product and package development

REQUESTING PRODUCT PLATING

1. If requesting Tin/Lead plated devices, add the suffix "TIN/LEAD" to the part number when ordering (example: 2N2222A TIN/LEAD).
2. If requesting Lead (Pb) Free plated devices, add the suffix "PBFREE" to the part number when ordering (example: 2N2222A PBFREE).

CONTACT US

Corporate Headquarters & Customer Support Team

Central Semiconductor Corp.
145 Adams Avenue
Hauppauge, NY 11788 USA
Main Tel: (631) 435-1110
Main Fax: (631) 435-1824
Support Team Fax: (631) 435-3388
www.centrasemi.com

Worldwide Field Representatives:
www.centrasemi.com/wwreps

Worldwide Distributors:
www.centrasemi.com/wwdistributors

For the latest version of Central Semiconductor's **LIMITATIONS AND DAMAGES DISCLAIMER**, which is part of Central's Standard Terms and Conditions of sale, visit: www.centrasemi.com/terms