

CMPLC1V5
CMPLC1V5D

**SURFACE MOUNT SILICON
LOW CAPACITANCE
ESD TRANSIENT
DATA LINE PROTECTORS**



www.centrasemi.com



SOT-23 CASE

DESCRIPTION:

CENTRAL SEMICONDUCTOR CMPLC1V5 (Single) and CMPLC1V5D (Dual) types are low capacitance silicon ESD Transient data line protectors packaged in the SOT-23 surface mount package. These devices provide protection to sensitive electronic devices from spurious ESD voltage transients and feature the lowest breakdown voltage available today making them ideal for circuits operating as low as 1.2V and 1.5V DC. Typical applications include: high speed data lines, mobile phones, PDA's, microcontrollers, microprocessor I/O interfaces, and LAN/WAN equipment.

MARKING CODES:

CMPLC1V5 (SINGLE): CLV5

CMPLC1V5D (DUAL): CV5D

MAXIMUM RATINGS: ($T_A=25^\circ\text{C}$)

Reverse Stand-off Voltage
Peak Power Dissipation (8x20 μs)
Peak Pulse Current (8x20 μs)
Electrical Fast Transient (IEC 61000-4-4) (5x50ns)
ESD Voltage (IEC 61000-4-2, Air)
ESD Voltage (IEC 61000-4-2, Contact)
Operating Temperature
Storage Temperature

SYMBOL

V_{RWM} 1.5
 P_{PK} 50
 I_{PP} 5.0
EFT 40
 V_{ESD} 25
 V_{ESD} 25
 T_J -50 to +125
 T_{stg} -50 to +150

UNITS

V
W
A
A
kV
kV
 $^\circ\text{C}$
 $^\circ\text{C}$

ELECTRICAL CHARACTERISTICS: ($T_A=25^\circ\text{C}$ unless otherwise noted)

Maximum Reverse Stand-off Voltage V_{RWM}	Minimum Breakdown Voltage $V_{BR} @ I_T$	Test Current I_T	Maximum Reverse Leakage Current $I_R @ V_{RWM}$	Maximum Clamping Voltage (8x20 μs)		Typical TLP Clamping Voltage (Note 1)		Typical Dynamic Resistance (Note 1) R_{DYN}	Maximum Junction Capacitance @ 0V Bias C_J
				$V_C @ I_{PP}$	I_{PP}	$V_{CL} @ I_{PP}$	I_{PP}		
V	V	mA	μA	V	A	V	A	Ω	pF
1.5	1.75	0.1	1.0	4.0	1.0	6.0	3.6	0.97	10
	2.1	1.0		7.0	3.0	13	10.8		

Note 1: Transmission Line Pulse (TLP) conditions: $Z_0=50\Omega$, $t_p=100\text{ns}$

CMPLC1V5
CMPLC1V5D

SURFACE MOUNT SILICON
LOW CAPACITANCE
ESD TRANSIENT
DATA LINE PROTECTORS



SOT-23 CASE - MECHANICAL OUTLINE

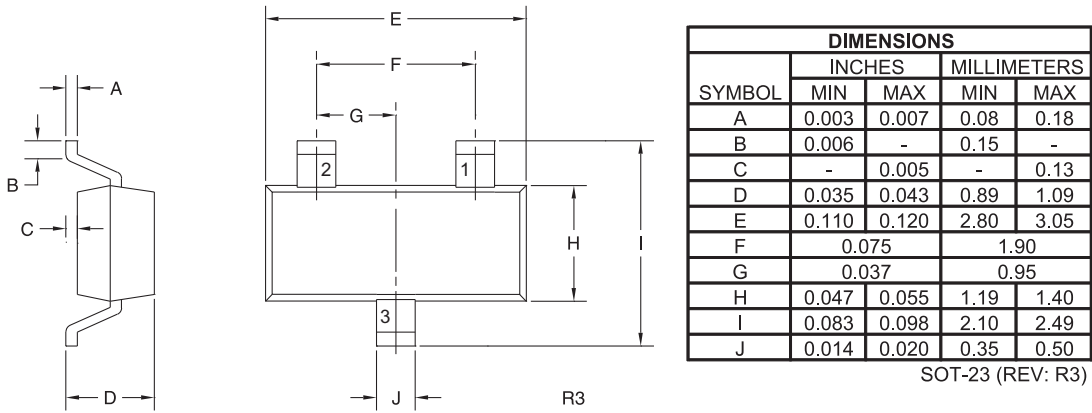

PIN CONFIGURATIONS

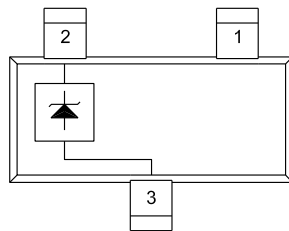

CMPLC1V5

LEAD CODE:

- 1) No Connection
- 2) Line 2
- 3) Ground

MARKING CODE: CLV5

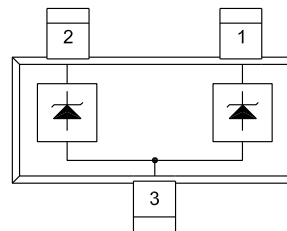

CMPLC1V5D

LEAD CODE:

- 1) Line 1
- 2) Line 2
- 3) Ground

MARKING CODE: CV5D

R3 (15-October 2015)

CMPLC1V5
CMPLC1V5D

SURFACE MOUNT SILICON
LOW CAPACITANCE
ESD TRANSIENT
DATA LINE PROTECTORS



TYPICAL ELECTRICAL CHARACTERISTICS

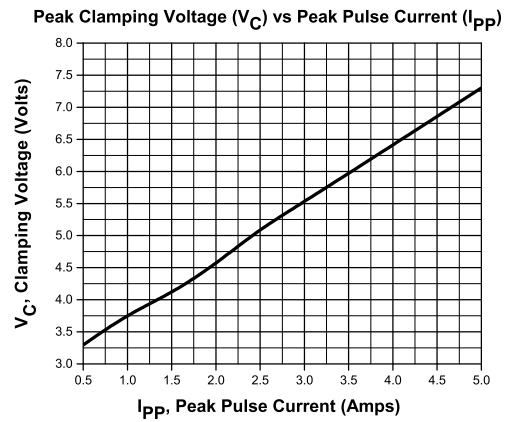
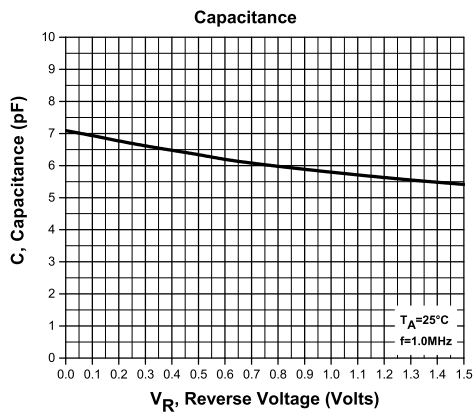
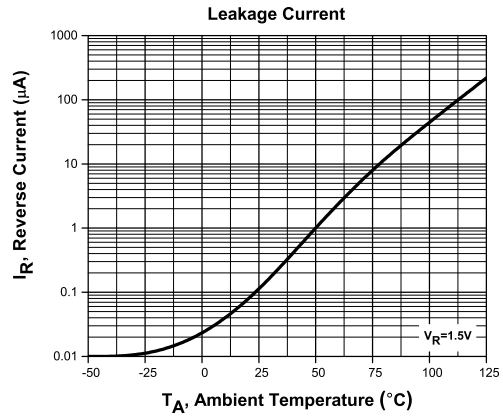
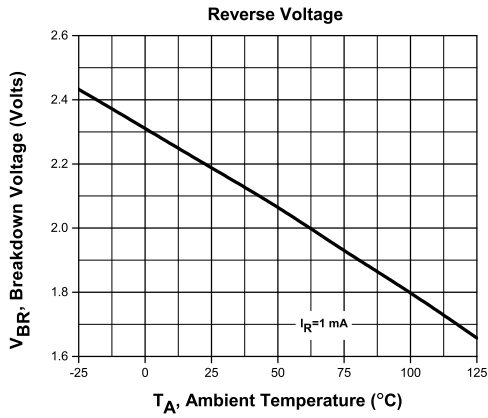

R3 (15-October 2015)

CMPLC1V5
CMPLC1V5D

SURFACE MOUNT SILICON
LOW CAPACITANCE
ESD TRANSIENT
DATA LINE PROTECTORS



TYPICAL ELECTRICAL CHARACTERISTICS

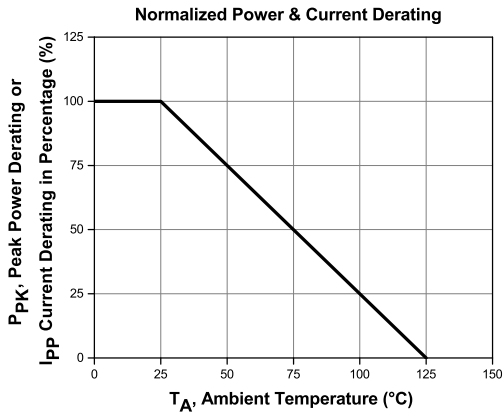
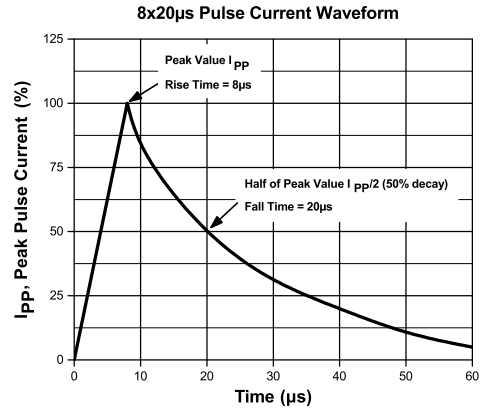
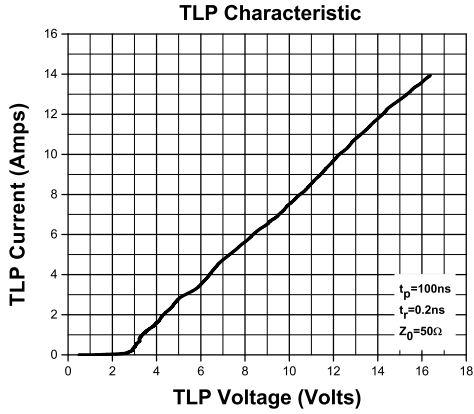

R3 (15-October 2015)

OUTSTANDING SUPPORT AND SUPERIOR SERVICES



PRODUCT SUPPORT

Central's operations team provides the highest level of support to insure product is delivered on-time.

- Supply management (Customer portals)
- Inventory bonding
- Consolidated shipping options
- Custom bar coding for shipments
- Custom product packing

DESIGNER SUPPORT/SERVICES

Central's applications engineering team is ready to discuss your design challenges. Just ask.

- Free quick ship samples (2nd day air)
- Online technical data and parametric search
- SPICE models
- Custom electrical curves
- Environmental regulation compliance
- Customer specific screening
- Up-screening capabilities
- Special wafer diffusions
- PbSn plating options
- Package details
- Application notes
- Application and design sample kits
- Custom product and package development

REQUESTING PRODUCT PLATING

1. If requesting Tin/Lead plated devices, add the suffix " TIN/LEAD" to the part number when ordering (example: 2N2222A TIN/LEAD).
2. If requesting Lead (Pb) Free plated devices, add the suffix " PBFREE" to the part number when ordering (example: 2N2222A PBFREE).

CONTACT US

Corporate Headquarters & Customer Support Team

Central Semiconductor Corp.
145 Adams Avenue
Hauppauge, NY 11788 USA
Main Tel: (631) 435-1110
Main Fax: (631) 435-1824
Support Team Fax: (631) 435-3388
www.centrasemi.com

Worldwide Field Representatives:
www.centrasemi.com/wwreps

Worldwide Distributors:
www.centrasemi.com/wwdistributors

For the latest version of Central Semiconductor's **LIMITATIONS AND DAMAGES DISCLAIMER**, which is part of Central's Standard Terms and Conditions of sale, visit: www.centrasemi.com/terms